

High-efficiency Circulator Pump

Calio Z

Installation/Operating Manual



Legal information/Copyright

Installation/Operating Manual Calio Z

Original operating manual

All rights reserved. The contents provided herein must neither be distributed, copied, reproduced, edited or processed for any other purpose, nor otherwise transmitted, published or made available to a third party without the manufacturer's express written consent.

Subject to technical modification without prior notice.

© KSB SE & Co. KGaA, Frankenthal 24/06/2020

Contents

	Glossary	5
1	General.....	6
	1.1 Principles	6
	1.2 Target group.....	6
	1.3 Other applicable documents.....	6
	1.4 Symbols	6
	1.5 Key to safety symbols/markings.....	7
2	Safety	8
	2.1 General.....	8
	2.2 Intended use	8
	2.2.1 Prevention of foreseeable misuse	8
	2.3 Personnel qualification and training.....	9
	2.4 Consequences and risks caused by non-compliance with this manual	9
	2.5 Safety awareness	9
	2.6 Safety information for the operator/user	9
	2.7 Safety information for maintenance, inspection and installation	10
	2.8 Unauthorised modes of operation	10
3	Transport/Storage/Disposal	11
	3.1 Checking the condition upon delivery	11
	3.2 Transport.....	11
	3.2.1 Placing the pump set down.....	12
	3.3 Storage/preservation	12
	3.4 Return to supplier.....	13
	3.5 Disposal	13
4	Description.....	14
	4.1 General description	14
	4.2 Product information as per Regulation No. 1907/2006 (REACH).....	14
	4.3 Designation.....	14
	4.4 Name plate.....	15
	4.5 Design details.....	15
	4.6 Configuration and function.....	17
	4.7 Noise characteristics	18
	4.8 Scope of supply.....	18
	4.9 Dimensions and weight.....	18
	4.10 Accessories	18
5	Installation at Site	19
	5.1 Safety regulations.....	19
	5.2 Checks to be carried out prior to installation	19
	5.3 Installing the pump set	19
	5.4 Connecting the piping	22
	5.5 Enclosure/insulation	22
	5.6 Electrical connection	23
	5.6.1 Connecting the cables	24
6	Commissioning/Start-up/Shutdown.....	33
	6.1 Commissioning/Start-up	33
	6.1.1 Prerequisites for commissioning/start-up	33
	6.1.2 Priming and venting the pump.....	33
	6.1.3 Start-up.....	34
	6.2 Operating limits.....	35
	6.2.1 Frequency of starts.....	35
	6.2.2 Ambient temperature.....	35

6.2.3	Minimum inlet pressure.....	35
6.2.4	Maximum operating pressure	36
6.2.5	Fluid handled	36
6.3	Shutdown/storage/preservation	37
6.3.1	Shutdown	37
6.3.2	Measures to be taken for shutdown	37
6.4	Returning to service	37
7	Operation.....	38
7.1	Control panel	38
7.1.1	Display	39
7.2	Operating modes.....	40
7.2.1	Information about settings	40
7.2.2	Constant-pressure control	41
7.2.3	Proportional-pressure control	43
7.2.4	Eco Mode.....	45
7.2.5	Open-loop control	47
7.2.6	Temperature-governed differential pressure control	48
7.3	Functions.....	49
7.3.1	Remote ON/OFF (digital input)	49
7.3.2	External analog 0 - 10 V DC signal.....	49
7.3.3	Dual-pump operation (DUAL).....	51
7.3.4	Modbus.....	52
7.3.5	Ramps	57
7.3.6	Deblocking the impeller.....	57
7.3.7	Temperature monitoring.....	57
7.3.8	Monitoring equipment.....	57
7.3.9	Saving data.....	57
7.3.10	General fault messages.....	58
7.4	Additional functions.....	59
7.4.1	Locking the control panel	59
7.4.2	Setback operation.....	60
7.4.3	Dynamic control.....	61
7.4.4	Information	63
7.5	Resetting the factory setting	63
8	Servicing/Maintenance.....	64
8.1	Maintenance/inspection.....	64
8.2	Drainage/cleaning	64
8.3	Removing the pump set from the piping	64
9	Trouble-shooting.....	66
10	Related Documents	68
10.1	Exploded view with list of components.....	68
10.2	Wiring diagram.....	68
11	EU Declaration of Conformity	69
	Index	70

Glossary

Discharge line

The pipeline which is connected to the discharge nozzle

Pump

Machine without drive, additional components or accessories

Pump set

Complete pump set consisting of pump, drive, additional components and accessories

Setback operation

Setback Operation avoids running the pump set at an unchanged control curve during the night. It lowers the mass flow rate, noise level and power consumption.

Suction lift line/suction head line

The pipeline which is connected to the suction nozzle

1 General

1.1 Principles

This operating manual is valid for the type series and variants indicated on the front cover.

The operating manual describes the proper and safe use of this equipment in all phases of operation.

The name plate indicates the type series and size as well as the main operating data. They uniquely identify the pump (set) and serve as identification for all further business processes.

In the event of damage, immediately contact your nearest KSB service facility to maintain the right to claim under warranty.

1.2 Target group

This operating manual is aimed at the target group of trained and qualified specialist technical personnel. (⇒ Section 2.3, Page 9)

1.3 Other applicable documents

Table 1: Overview of other applicable documents

Document	Contents
Data sheet	Description of the technical data of the pump (set)

For accessories and/or integrated machinery components observe the relevant manufacturer's product literature.









1.4 Symbols

Table 2: Symbols used in this manual

Symbol	Description
✓	Conditions which need to be fulfilled before proceeding with the step-by-step instructions
▷	Safety instructions
⇒	Result of an action
⇔	Cross-references
1. 2.	Step-by-step instructions
	Note Recommendations and important information on how to handle the product

1.5 Key to safety symbols/markings

Table 3: Definition of safety symbols/markings

Symbol	Description
	DANGER This signal word indicates a high-risk hazard which, if not avoided, will result in death or serious injury.
	WARNING This signal word indicates a medium-risk hazard which, if not avoided, could result in death or serious injury.
	CAUTION This signal word indicates a hazard which, if not avoided, could result in damage to the machine and its functions.
	General hazard In conjunction with one of the signal words this symbol indicates a hazard which will or could result in death or serious injury.
	Electrical hazard In conjunction with one of the signal words this symbol indicates a hazard involving electrical voltage and identifies information about protection against electrical voltage.
	Machine damage In conjunction with the signal word CAUTION this symbol indicates a hazard for the machine and its functions.
	Warning: Strong magnetic field In conjunction with one of the signal words this symbol indicates a hazard involving magnetic fields and identifies information about protection against magnetic fields.
	Warning for persons with pacemaker In conjunction with one of the signal words this symbol indicates a hazard involving magnetic fields and identifies special information for persons with a pacemaker.
	Warning about hot surfaces In conjunction with one of the signal words this symbol indicates a hazard involving hot surfaces.



2 Safety

All the information contained in this section refers to hazardous situations.

In addition to the present general safety information the action-related safety information given in the other sections must be observed.

2.1 General

- This operating manual contains general installation, operating and maintenance instructions that must be observed to ensure safe operation of the system and prevent personal injury and damage to property.
- Comply with all the safety instructions given in the individual sections of this operating manual.
- The operating manual must be read and understood by the responsible specialist personnel/operators prior to installation and commissioning.
- The contents of this operating manual must be available to the specialist personnel at the site at all times.
- Information and markings attached directly to the product must always be complied with and kept in a perfectly legible condition at all times. This applies to, for example:
 - Flow direction arrow
 - Markings for connections
 - Name plate
- The operator is responsible for ensuring compliance with all local regulations not taken into account.

2.2 Intended use

- The pump (set) must only be operated in the fields of application and within the use limits specified in the other applicable documents.
- Only operate pumps/pump sets which are in perfect technical condition.
- Do not operate the pump (set) in partially assembled condition.
- Only use the pump to handle the fluids described in the data sheet or product literature of the pump model or variant.
- Never operate the pump without the fluid to be handled.
- Observe the minimum flow rate and maximum flow rate indicated in the data sheet or product literature (e.g. to prevent overheating, cavitation damage, bearing damage).
- Do not throttle the flow rate on the suction side of the pump (to prevent cavitation damage).
- Consult the manufacturer about any use or mode of operation not described in the data sheet or product literature.

2.2.1 Prevention of foreseeable misuse

- Observe all safety information and instructions in this manual.
- Never exceed the permissible application and operating limits specified in the data sheet or product literature regarding pressure, temperature, etc.

2.3 Personnel qualification and training

All personnel involved must be fully qualified to transport, install, operate, maintain and inspect the equipment this manual refers to.

The responsibilities, competence and supervision of all personnel involved in transport, installation, operation, maintenance and inspection must be clearly defined by the operator.

Deficits in knowledge must be rectified by means of training and instruction provided by sufficiently trained specialist personnel. If required, the operator can commission the manufacturer/supplier to train the personnel.

Training on the pump (set) must always be supervised by technical specialist personnel.

This device may be operated by **children** from the age of 8 as well as by persons of limited physical, sensory or mental abilities or lacking experience and knowledge, provided that they are supervised, they have been instructed on how to use this device safely and they understand the hazards it presents. It is impermissible for **children** to play with this device. **Children** must not clean the device or perform any **service work to be carried out by the operator** at the device without supervision.

2.4 Consequences and risks caused by non-compliance with this manual

- Non-compliance with these operating instructions will lead to forfeiture of warranty cover and of any and all rights to claims for damages.
- Non-compliance can, for example, have the following consequences:
 - Hazards to persons due to electrical, thermal, mechanical and chemical effects and explosions
 - Failure of important product functions
 - Failure of prescribed maintenance and servicing practices
 - Hazard to the environment due to leakage of hazardous substances

2.5 Safety awareness

In addition to the safety information contained in this operating manual and the intended use, the following safety regulations shall be complied with:

- Accident prevention, health regulations and safety regulations
- Explosion protection regulations
- Safety regulations for handling hazardous substances
- Applicable standards, directives and laws

2.6 Safety information for the operator/user

- Fit protective equipment (e.g. contact guards) supplied by the operator for hot, cold or moving parts, and check that the equipment functions properly.
- Do not remove any protective equipment (e.g. contact guards) during operation.
- Contain leakages (e.g. at the shaft seal) of hazardous fluids handled (e.g. explosive, toxic, hot) so as to avoid any danger to persons and the environment. Adhere to all relevant laws.
- Eliminate all electrical hazards. (In this respect refer to the applicable national safety regulations and/or regulations issued by the local energy supply companies.)
- If shutting down the pump does not increase potential risk, fit an emergency-stop control device in the immediate vicinity of the pump (set) during pump set installation.

2.7 Safety information for maintenance, inspection and installation

- Modifications or alterations of the pump (set) are only permitted with the manufacturer's prior consent.
- Use only original spare parts or parts/components authorised by the manufacturer. The use of other parts/components can invalidate any liability of the manufacturer for resulting damage.
- The operator ensures that maintenance, inspection and installation are performed by authorised, qualified specialist personnel who are thoroughly familiar with the manual.
- Only carry out work on the pump (set) during standstill of the pump.
- Only perform work on the pump set when it has been disconnected from the power supply (de-energised).
- The pump (set) must have cooled down to ambient temperature.
- Pump pressure must have been released and the pump must have been drained.
- When taking the pump set out of service always adhere to the procedure described in the manual. (⇒ Section 6.3, Page 37) (⇒ Section 6.3.2, Page 37)
- Decontaminate pumps which handle fluids posing a health hazard.
- As soon as the work has been completed, re-install and re-activate any safety-relevant devices and protective devices. Before returning the product to service, observe all instructions on commissioning. (⇒ Section 6.1, Page 33)

2.8 Unauthorised modes of operation

Never operate the pump (set) outside the limits stated in the data sheet and in this manual.



The warranty relating to the operating reliability and safety of the supplied pump (set) is only valid if the equipment is used in accordance with its intended use.

3 Transport/Storage/Disposal

3.1 Checking the condition upon delivery

1. On transfer of goods, check each packaging unit for damage.
2. In the event of in-transit damage, assess the exact damage, document it and notify KSB or the supplying dealer and the insurer about the damage in writing immediately.

3.2 Transport

	 DANGER
	<p>The pump (set) could slip out of the suspension arrangement Danger to life from falling parts!</p> <ul style="list-style-type: none"> ▷ Always transport the pump (set) in the specified position. ▷ Observe the information on weights, centre of gravity and fastening points. ▷ Observe the applicable local accident prevention regulations. ▷ Use suitable, approved lifting accessories.

To transport the pump/pump set suspend it from the lifting tackle as shown.



Fig. 1: Correct pump transport



Fig. 2: Incorrect pump transport

3.2.1 Placing the pump set down

	<p>⚠ WARNING</p>
	<p>Insufficient stability Risk of crushing hands and feet!</p> <ul style="list-style-type: none"> ▸ During assembly/dismantling, secure the pump (set)/pump parts to prevent tilting or tipping over.

Place the pump set down as illustrated.

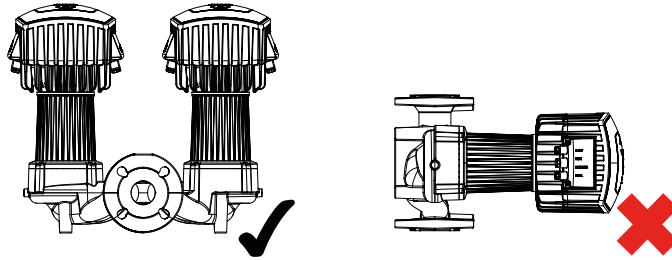



Fig. 3: Placing the pump set down safely

3.3 Storage/preservation

	<p>CAUTION</p>
	<p>Damage during storage due to humidity, dirt or vermin Corrosion/contamination of the pump (set)!</p> <ul style="list-style-type: none"> ▸ For outdoor storage cover the pump (set) or the packaged pump (set) and accessories with waterproof material.
	<p>CAUTION</p>
	<p>Wet, contaminated or damaged openings and connections Leakage or damage to the pump!</p> <ul style="list-style-type: none"> ▸ Clean and cover pump openings and connections as required prior to putting the pump into storage.

If commissioning is to take place some time after delivery, we recommend that the following measures be taken :

Store the pump (set) in a dry, protected room at constant atmospheric humidity.

If properly stored indoors, the equipment is protected for a maximum of 12 months. New pumps/pump sets are supplied by our factory duly prepared for storage.

For storing a pump (set) which has been operated, observe the instructions in (⇒ Section 6.3.2, Page 37) .

Table 4: Ambient conditions for storage

Ambient condition	Value
Relative humidity	80 % maximum
Ambient temperature	0 °C to +40 °C

- Well-ventilated
- Dry
- Dust-free
- Shock-free
- Vibration-free

3.4 Return to supplier

1. Prior to returning the product to the supplier, flush and clean it, particularly if it has been used in noxious, explosive, hot or other hazardous fluids.
2. If the product has been used in fluids whose residues could lead to corrosion damage in the presence of atmospheric humidity or could ignite upon contact with oxygen, the product must also be neutralised and treated with anhydrous inert gas to ensure drying.
3. Always complete and enclose a certificate of decontamination when returning the product.
Indicate any safety measures and decontamination measures taken.

	NOTE
<p>If required, a blank certificate of decontamination can be downloaded from the following web site: www.ksb.com/certificate_of_decontamination</p>	

3.5 Disposal

	⚠ DANGER
<p>Strong magnetic field in the rotor area Danger of death for persons with pacemaker! Interference with magnetic data carriers, electronic devices, components and instruments! Uncontrolled magnetic attraction forces between magnet-equipped components, tools or similar!</p> <ul style="list-style-type: none"> ▷ Keep a safety distance of at least 0.3 m. 	

	⚠ WARNING
<p>Fluids handled, consumables and supplies which are hot and/or pose a health hazard Hazard to persons and the environment!</p> <ul style="list-style-type: none"> ▷ Collect and properly dispose of flushing fluid and any fluid residues. ▷ Wear safety clothing and a protective mask if required. ▷ Observe all legal regulations on the disposal of fluids posing a health hazard. 	

1. Dismantle the pump (set).
Collect greases and other lubricants during dismantling.
2. Separate and sort the pump materials, e.g. by:
 - Metals
 - Plastics
 - Electronic waste
 - Greases and other lubricants
3. Dispose of materials in accordance with local regulations or in another controlled manner.

Electrical or electronic equipment marked with the adjacent symbol must not be disposed of in household waste at the end of its service life.

Contact your local waste disposal partner for returns.

If the used electrical or electronic equipment contains personal data, the operator is responsible for deleting it before the equipment is returned.

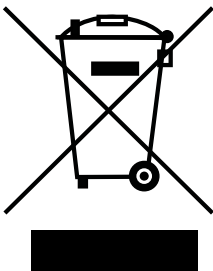

1157.841/06-EN

4 Description

4.1 General description

- High-efficiency circulator pumps with continuously variable speed control
- Non-self-priming in-line pump with integrated permanent magnet motor and electronic variable speed system

Pump for handling clean, non-aggressive fluids which are not chemically and mechanically aggressive to the pump materials.

4.2 Product information as per Regulation No. 1907/2006 (REACH)

For information as per chemicals Regulation (EC) No. 1907/2006 (REACH), see <http://www.ksb.com/reach>.

4.3 Designation

Example: Calio Z 40-180

Table 5: Designation key

Code	Description	
Calio Z	Type series	
40	Connection	
	30	Rp 1 1/4
	32	DN 32
	40	DN 40
	50	DN 50
	65	DN 65
180	Head H ¹⁾ [m]	
	180	Head × 10 Example: 18 m × 10 = 180

1) At flow rate Q = 0 m³/h

4.4 Name plate

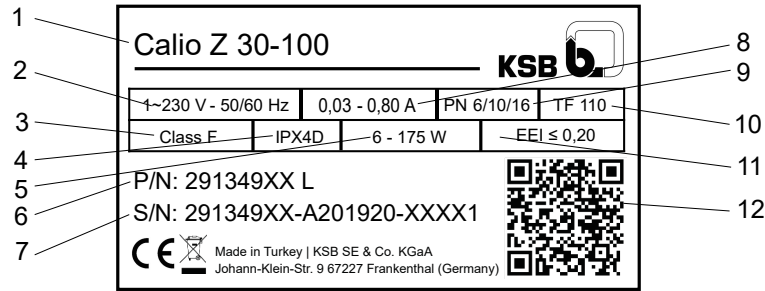

Fig. 4: Name plate (example)

1	Type series, size	7	Production number
2	Mains voltage, frequency	8	Current input
3	Thermal class	9	Pressure class
4	Enclosure	10	Temperature class
5	Power input	11	Energy efficiency index EEI
6	Material number	12	QR code

Key to the production number

Example: 291348XX-A201920-XXXX1

Table 6: Key to the production number

Code	Description
291348XX	Material number
2019	Year of production
20	Week of production
XXXX1	Consecutive number

4.5 Design details

Design

- Maintenance-free high-efficiency wet rotor pump (glandless)
- Twin pump

Drive

- High-efficiency permanent magnet synchronous motor, brushless, self-cooling, with continuously variable differential pressure control
- Integrated motor protection
- 1~230 V AC +/- 10%
- Frequency 50 Hz/60 Hz
- Enclosure IPX4D
- Thermal class F
- Temperature class TF 110
- Energy efficiency index $EEI \leq 0.23$
- Interference emissions EN 61000-6-3
- Interference immunity EN 61000-6-1

Bearings

- Product-lubricated special plain bearing

Connections

- Screw-ended or flanged

Operating modes

- Constant-pressure control
- Proportional-pressure control
- Temperature-governed differential pressure control (can only be activated with KSB ServiceTool)
- Open-loop control via setpoint setting
- Eco Mode

Automatic functions

- Continuously variable speed adjustment depending on the mode of operation
- 0 - 10 V with external differential pressure/speed setpoint
- 0 - 10 V as input of the actual value of the temperature or actual value of the differential pressure
- Pump changeover after 24 hours runtime of a pump
- Redundancy by automatic start-up of the stand-by pump in the event of a duty pump failure
- Dual-pump operation
- Peak load operation
- Setback operation
- Dynamic Control
- Remote ON/OFF
- Deblocking function
- Self-venting function
- Soft start
- Full motor protection with integrated trip electronics

Manual functions

- Setting the operating mode
- Setting the differential pressure setpoint
- Setting the speed level
- Locking the control panel

Signalling functions and display functions

- Periodically alternating display of flow rate, head and electrical input power
- Operating status shown on the display
- Error codes indicated on the display
- Configurable general fault messages and "in operation" messages (volt-free changeover contacts)
- Serial digital Modbus RTU interface
- Service interface for KSB ServiceTool

4.6 Configuration and function

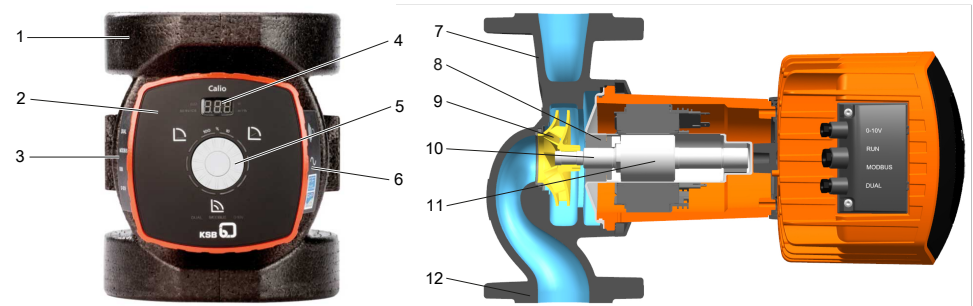

Fig. 5: Description and sectional drawing of the pump set

1	Thermal insulation shell	7	Discharge nozzle
2	Control panel	8	Radial plain bearing
3	Connections for control cables	9	Impeller
4	Display	10	Motor shaft
5	Control element (dial and control button)	11	Motor
6	Connections for power supply, "in operation" message and general fault message	12	Suction nozzle

Design The pump is designed with a radial fluid inlet (suction nozzle) and a radial outlet (discharge nozzle) arranged on the same axis. The impeller is rigidly connected to the motor shaft. Mechanical sealing is not required as the rotating assembly is completely isolated from the stator winding. The rotating assembly is lubricated and cooled by the fluid handled. The lubricating system, high-quality graphite bearings and precision-balanced rotor ensure smooth running and a long service life. The integrated continuously variable differential pressure control and operating software enable an optimum adjustment of the pump to changing operating conditions and minimise operating costs. The combination of an efficient hydraulic system with a high-efficiency electric motor makes sure that the input power is converted into hydraulic energy as efficiently as possible.

Function The fluid enters the pump via the suction nozzle (12) and is accelerated outward in a cylindrical flow by the rotating impeller (9). In the flow passage of the pump casing the kinetic energy of the fluid is converted into pressure energy. The fluid is pumped to the discharge nozzle (7), where it leaves the pump. The shaft runs in radial plain bearings (8), which are supported by the motor (11).

4.7 Noise characteristics

Average sound pressure level < 45 dB (A)²⁾

4.8 Scope of supply

Depending on the model, the following items are included in the scope of supply:

- Pump set
- Pre-configured dual connection cable
- 2 gaskets
- Installation/operating manual

4.9 Dimensions and weight

For dimensions and weights please refer to the type series booklet of the pump (set).



4.10 Accessories

- BACnet MS/TP communication module
- Spacer

2) Calio Z 100-60 < 49 dB (A)

5 Installation at Site

5.1 Safety regulations

	<div style="background-color: #e67e22; color: white; padding: 5px;">⚠ DANGER</div> <p>Installation in potentially explosive atmospheres Explosion hazard!</p> <ul style="list-style-type: none"> ▷ Never install the pump in potentially explosive atmospheres. ▷ Observe the information given in the data sheet and on the name plates of the pump system.
	<div style="background-color: #e67e22; color: white; padding: 5px;">⚠ DANGER</div> <p>Use for drinking water or foodstuff applications Danger of poisoning!</p> <ul style="list-style-type: none"> ▷ Never use the pump for drinking water or foodstuff applications.
	<div style="background-color: #f1c40f; padding: 5px;">CAUTION</div> <p>Improper installation of the pump set Damage to the pump set!</p> <ul style="list-style-type: none"> ▷ Observe the permissible ambient conditions and the pump set's type of enclosure. ▷ Observe the permissible ambient temperatures. Ambient temperatures < 0 °C are not permitted. ▷ In the event of outdoor installation, fit a protective roof to protect the pump set from the weather (e. g. sun, rain, snow).





5.2 Checks to be carried out prior to installation

Before beginning with the installation check the following:

- The pump set can be operated on the power supply network according to the data on the name plate. (⇒ Section 4.4, Page 15)
- The fluid to be handled matches the description of suitable fluids. (⇒ Section 6.2.5.1, Page 36)
- All structural work required has been checked and prepared in accordance with the dimensions in the outline drawing.

5.3 Installing the pump set

	<div style="background-color: #e67e22; color: white; padding: 5px;">⚠ DANGER</div> <p>Leakage at the pump Hot fluids escaping!</p> <ul style="list-style-type: none"> ▷ Fit the sealing elements and make sure they are positioned correctly.
---	--

	<p>CAUTION</p> <p>Ingress of fluid into the motor Damage to the pump set!</p> <ul style="list-style-type: none"> ▷ Install the pump set with the pump shaft in a horizontal position. Connect the piping without transmitting any stresses and strains. ▷ Never install the pump set with the motor terminal box pointing downwards. ▷ Undo the hexagon socket head cap screws. Then turn the motor housing.
	<p>CAUTION</p> <p>Air entering the pump Damage to vertically installed pump sets whose direction of flow is downwards!</p> <ul style="list-style-type: none"> ▷ Fit a vent valve at the highest point of the suction line.
	<p>NOTE</p> <p>Installing shut-off valves upstream and downstream of the pump set is recommended. Make sure that no leakage water can drip onto the drive or terminal box.</p>
	<p>NOTE</p> <p>The direction of flow of a vertically installed pump should be upwards.</p>
	<p>NOTE</p> <p>Do not install the pump at the lowest point of the system to prevent any impurities from collecting in the pump.</p>

Positioning the control unit

	<p>WARNING</p> <p>Insufficient stability Risk of crushing hands and feet!</p> <ul style="list-style-type: none"> ▷ During assembly/dismantling, secure the pump (set)/pump parts to prevent tilting or tipping over.
---	--

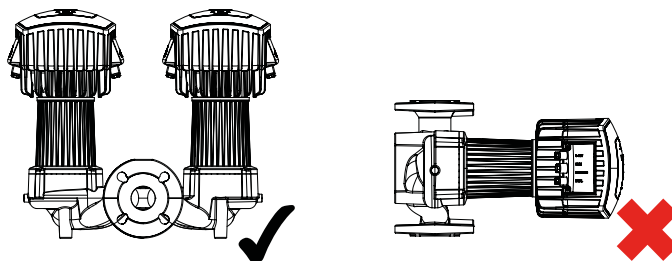

Fig. 6: Placing the pump set down safely

The control unit can be turned through 360°. The position must be effected with the pump set removed from the system.

- ✓ The pump set is secured against tipping over.
 1. Undo and store the 4 hexagon socket head cap screws.
 2. Rotate the drive unit until it has reached the required position. Compare it against the permissible installation positions. Adjust the position if required.
 3. Fit and tighten the 4 hexagon socket head cap screws again.

Permissible installation positions

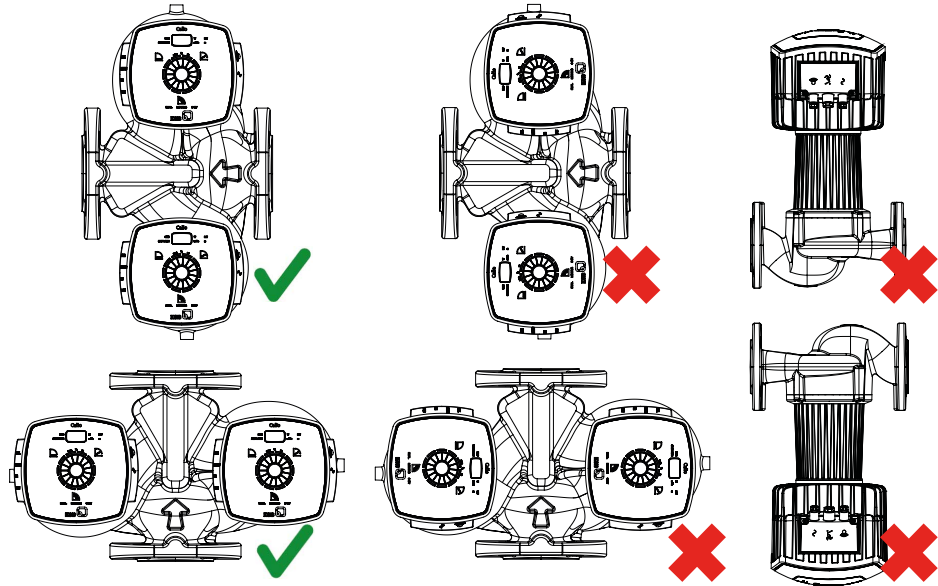

Fig. 7: Permissible installation positions

	<p>⚠ DANGER</p>
	<p>Leakage at the pump Leakage of hot fluids!</p> <p>▷ Insert the O-ring in the correct position.</p>





Screw-ended pump

1. Position the pump set as indicated in an easily accessible place.
 - ⇒ An arrow on the pump casing and thermal insulation shell indicates the direction of flow.
2. Accurately insert the sealing element.
3. Connect the pump and piping with a pipe union.
4. Tighten the pipe union hand-tight with an assembly tool (e.g. pipe wrench).
5. Accurately insert the sealing element in the opposite pipe union.
6. Tighten the pipe union hand-tight with an assembly tool (e.g. pipe wrench).

Flanged pump



1. Position the pump set as indicated in an easily accessible place.
 - ⇒ An arrow on the pump casing and thermal insulation shell indicates the direction of flow.
2. Accurately insert the sealing element.
3. Bolt the pump flange to the pipe flange.
4. Tighten the bolts hand-tight with an assembly tool (e.g. wrench).
5. Accurately insert the sealing element on the opposite side.
6. Bolt the pump flange to the pipe flange.
7. Tighten the bolts hand-tight with an assembly tool (e.g. wrench).

5.4 Connecting the piping

	<p>WARNING</p> <p>Hot surface Risk of burns</p> <ul style="list-style-type: none"> ▷ Never touch a pump set when it is in operation.
	<p>WARNING</p> <p>Impermissible loads acting on the pump nozzles Risk of burns by hot fluids escaping!</p> <ul style="list-style-type: none"> ▷ Do not use the pump as an anchorage point for the piping. ▷ Anchor the pipes in close proximity to the pump and connect them without transmitting any stresses or strains. ▷ Take appropriate measures to compensate for thermal expansion of the piping.
	<p>CAUTION</p> <p>Contamination/dirt in the piping Damage to the pump!</p> <ul style="list-style-type: none"> ▷ Flush the piping prior to commissioning or replacing the pump. Remove any foreign matter.
	<p>NOTE</p> <p>Installing check and shut-off elements in the system is recommended, depending on the type of plant and pump. However, such elements must not obstruct proper drainage or hinder disassembly of the pump.</p>







- ✓ Suction lift lines have been laid with a rising slope, suction head lines with a downward slope towards the pump.
 - ✓ The nominal diameters of the pipelines are equal to or greater than the nominal diameters of the pump nozzles.
 - ✓ The pipelines have been anchored in close proximity to the pump and connected without transmitting any stresses or strains.
1. Thoroughly clean, flush and blow through all vessels, pipelines and connections (especially of new installations).

5.5 Enclosure/insulation

	<p>WARNING</p> <p>The pump takes on same temperature as the fluid handled Risk of burns!</p> <ul style="list-style-type: none"> ▷ Insulate the volute casing. ▷ Fit protective equipment.
	<p>CAUTION</p> <p>Heat building up at motor housing and pump casing Pump overheating!</p> <ul style="list-style-type: none"> ▷ Never insulate the motor and electronic system housings.

1157.841/06-EN

5.6 Electrical connection

	<p>⚠ DANGER</p>
	<p>Electrical connection work by unqualified personnel Danger of death from electric shock!</p> <ul style="list-style-type: none"> ▷ Always have the electrical connections installed by a trained and qualified electrician. ▷ Observe the EN 61557 regulations as well as any regional regulations.
	<p>⚠ DANGER</p>
	<p>Electrostatic charging Danger of death from electric shock!</p> <ul style="list-style-type: none"> ▷ Provide potential equalisation between the pump set and the foundation.
	<p>⚠ DANGER</p>
	<p>Pump acting as a generator when running in reverse Danger to life from hazardous induction voltage at the motor terminals!</p> <ul style="list-style-type: none"> ▷ Prevent the fluid from flowing back by closing the shut-off elements.
	<p>⚠ DANGER</p>
	<p>Heat damage to the cable sheath Danger from electric shock!</p> <ul style="list-style-type: none"> ▷ Make sure the cables are never laid in contact with hot casings/housings or pipelines.
	<p>⚠ DANGER</p>
	<p>Hazardous electrical voltage when the covers of the terminal wiring compartments are removed Danger of death from electric shock!</p> <ul style="list-style-type: none"> ▷ For working on the terminals, switch off the power supply at least 5 minutes prior to commencing work and ensure that it cannot be switched on again unintentionally. ▷ If applicable, switch off the external power supply to message relays and control cables and make sure it cannot be switched on again unintentionally. ▷ Keep the covers of the terminal wiring compartments closed during operation as well as during maintenance work.
	<p>⚠ WARNING</p>
	<p>Incorrect connection to the mains Damage to the mains network, short circuit!</p> <ul style="list-style-type: none"> ▷ Observe the technical specifications of the local energy supply companies.
	<p>CAUTION</p>
	<p>Fluid entering cable glands or power supply installation Electronics failure, short circuit!</p> <ul style="list-style-type: none"> ▷ Lay cables in a loop so any water dripping onto the cables will run off.

1157.841/06-EN

	NOTE
	<p>The cable must be of type H05VV-F 3G1 or similar, with an outside diameter ≥ 7.2 mm. Circuit breaker: 10/16 A (minimal rated current x 1.4) slow blowing fuse or automatic circuit breaker type C.</p>
	NOTE
	<p>Using a plug-type connection for the power cable is impermissible.</p> <p>Connection to power supply must be effected by means of a fixed power cable with a minimum cross-section of 3×1.5 mm².</p> <p>Connection to the power supply must be effected by a power cable which is fitted with an all-pole isolating switch with a minimum contact opening of 3 mm.</p> <p>If the power cable of the device is damaged, have it replaced by the manufacturer, a customer service technician or a similarly qualified person. See EN 60335-1.</p>

Residual current device If residual current devices (RCDs) are used, frequency inverters must in accordance with DIN VDE 0160 be connected via universal AC/DC sensitive residual current devices (RCDs). Standard AC sensitive RCDs might either fail to respond or respond erroneously to any direct-current components which may be present. Discharge current per pump < 3.5 mA.

5.6.1 Connecting the cables

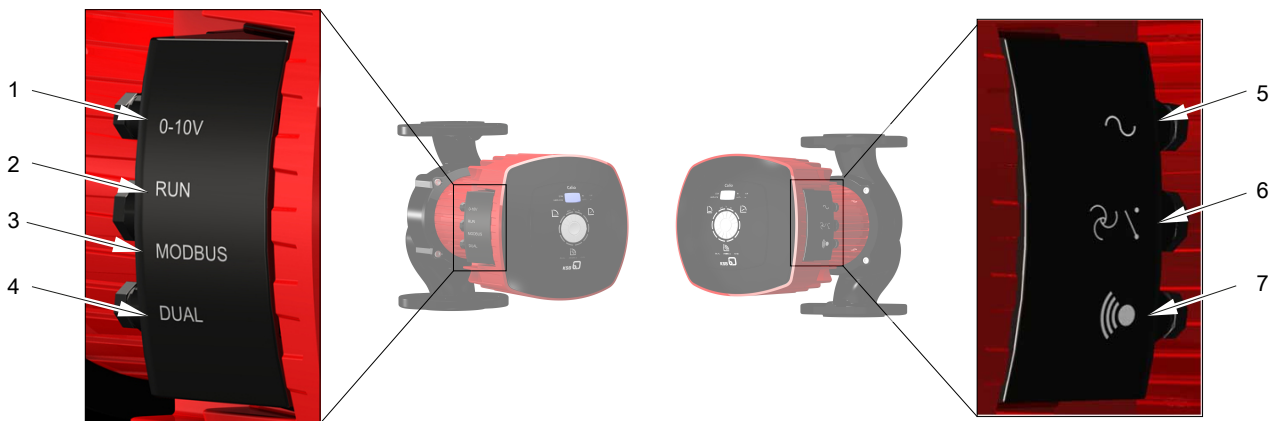

- | | |
|---|---|
| <ul style="list-style-type: none"> 1 Connection for external analog signal 0 - 10 V DC 2 Connection for remote ON/OFF signal 3 Connection to Modbus network 4 Connection for dual-pump operation (DUAL) | <ul style="list-style-type: none"> 5 Connection of power supply 1~ 230 V AC +/- 10 %, 50 Hz/60 Hz 6 Connection for "in operation" message 7 Connection for general fault message |
|---|---|

The left side has 4 connection options and 3 cable glands. If all 4 connections are to be used, run the control cables of connections 2 and 3 through the cable gland in the middle.

- ✓ The mains voltage at the site has been verified against the data on the name plate.
 - ✓ The pump set has been de-energised and secured against unintentional start-up.
 - ✓ The wiring diagram is on hand.
1. Unscrew the cable glands (IPX4D).
 2. Undo and store the 2 screws of the cover of the terminal wiring compartment.
 3. Remove the cover of the terminal wiring compartment.
 4. Knock out and remove the closing disc of the required cable gland with a suitable tool (e.g. screwdriver).
 5. Lay the required cable in a loop so any water will drip off, then guide it through the corresponding cable gland and connect it to the terminal provided.

6. Fit the cover of the terminal wiring compartment. Fasten it with the 2 screws.
7. Tighten the cable glands.

Table 7: Symbols key

Function	Symbol	Terminal pair	Terminal cross-section	Terminal code	Frequency of starts	Contact rating
External analog signal 0 - 10 V DC	0 - 10 V		1,5 mm ²	Vin = 0-10 V (+) 0 V = GND (-)	-	-
Signal for remote ON/OFF (supplied bridged)	RUN		1,5 mm ²	R = RUN contact 0 V = GND	-	-
Modbus network	Modbus		1,5 mm ²	D+ = D+ D- = D-	-	-
Dual-pump configuration	DUAL		1,5 mm ²	H = Signal High (+) L = Signal Low (-)	-	-
Power supply 1~ 230 V AC +/- 10 %, 50 Hz/60 Hz			1,5 mm ²	⊥ = PE N = N L = L	< 20 / 24 hours	-
"In operation" message			1,5 mm ²	-	-	Min: 12 V DC at 10 mA Max: 250 V at 1 A
General fault message			1,5 mm ²	-	-	Min: 12 V DC at 10 mA Max: 250 V at 1 A

5.6.1.1 Power supply

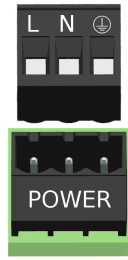

Fig. 8: Power supply 1~230 V AC +/- 10 %, 50 Hz/60 Hz

L	Conductor / phase (230 V)
N	Neutral conductor
⏚	Earthing

- ✓ The wiring diagram is on hand.
- 1. Connect the power supply to the terminal pair L, N, PE integrated in the pump set.

5.6.1.2 "In operation" message

The pump set signals its operating status by means of the integrated, volt-free relay contact.

- Pump not in operation = rotor not rotating, no flow (alarm active).
- Pump in operation = rotor rotating (alarm not active).

For configuring and inverting use the KSB ServiceTool as described in the KSB ServiceTool supplementary operating manual (reference number 1157.801).

The information can be accessed at the status terminal pair with terminals NC / COM / NO.

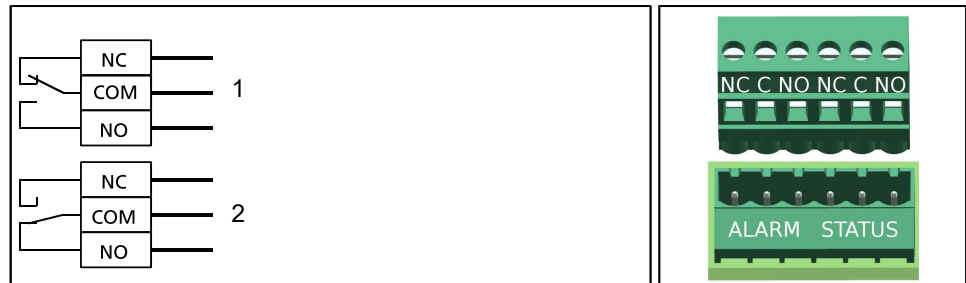

Fig. 9: Wiring diagram for the "in operation" message

1	Pump not in operation (rotor not rotating) / alert active
2	Pump in operation (rotor rotating) / alert not active
NC	NC contact, normally closed and electrically conductive connection to COM
COM	Reference potential for either contact that is closed
NO	NO contact, normally open and not electrically conductive connection to COM

5.6.1.3 General fault message

The pump set signals a general fault message by means of the integrated, volt-free relay contact.

- General fault message = rotor not rotating, no flow (alarm not active).

For configuring and inverting use the KSB ServiceTool as described in the KSB ServiceTool supplementary operating manual (reference number 1157.801).

The information can be accessed at the alarm terminal pair with terminals NC / COM / NO.



Fig. 10: Wiring diagram for the general fault message

1	No general fault message or no power supply / no alarm active
2	General fault message (rotor not rotating) / alarm active
NC	NC contact, normally closed and electrically conductive connection to COM
COM	Reference potential for either contact that is closed
NO	NO contact, normally open and not electrically conductive connection to COM

5.6.1.4 External analog 0 - 10 V DC signal

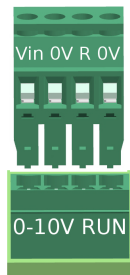

Fig. 11: Terminal pair 0-10 V

Vin	0-10 V (+)
R	Signal 5 V (+)
0 V	GND (-)

✓ The wiring diagram is on hand.

1. Connect the external analog signal to the 0-10 V terminal pair integrated in the pump set.

5.6.1.5 Remote ON/OFF

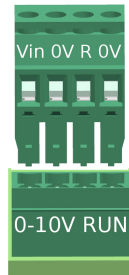

Fig. 12: RUN terminal pair

Vin	0-10 V (+)
R	Signal 5 V (+)
0 V	GND (-)

- ✓ The wiring diagram is on hand.
 1. Unscrew the cable glands (IPX4D).
 2. Wire the external signal (volt-free switching contact) to the RUN terminal pair integrated in the pump set. The terminal pair is supplied bridged.
 3. Tighten the cable glands (IPX4D).

5.6.1.6 Connecting the Modbus system

Connection to higher-level automation systems per Modbus at the example of four pumps

Communication between the connected pump sets and the Modbus master is effected via Modbus. Cable reflections occur at the open cable ends (first and last connection of a bus system). The higher the selected baud rate, the larger the cable reflections. Provide terminating resistors to establish a defined rest potential and keep reflections to a minimum.

- ✓ The control unit has been de-energised.
 1. Wire the pump sets at their Modbus terminals in line topology as illustrated.
 - ⇒ Use a network cable with a defined impedance (cable type B to TIA-485-A).
 2. Connect a terminating resistor of 120 Ω to the first and last Modbus device of a bus line.

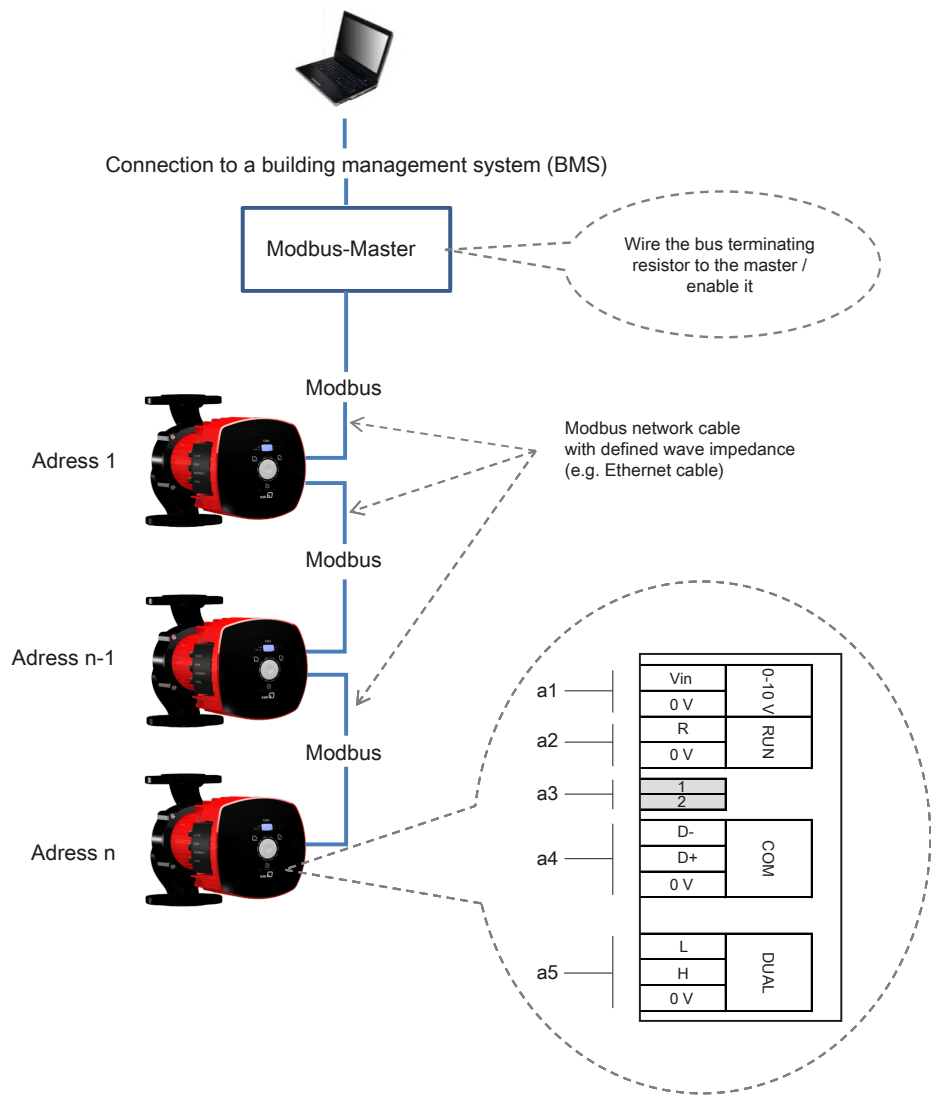

Fig. 13: Modbus wiring for the pump sets

Connection to bus systems with Modbus

Table 8: Technical data of the Modbus interface

Parameter	Description/value
Terminal cross-section	1,5 mm ²
Interface	RS485 (TIA-485-A) optically isolated
Bus connection	0.5 mm ² , shielded twisted pair bus cable
Cable length	<ul style="list-style-type: none"> ▪ 1000 m max. ▪ Stub line impermissible ▪ For cable lengths > 30 m take suitable measures to ensure overvoltage protection.
Wave impedance	120 Ω (cable type B to TIA-485-A)
Data rates [baud]	4800, 9600, 38,400, 57,600, 115,200 (19,200 = factory setting)
Protocol	Modbus RTU standard

1157.841/06-EN

Parameter	Description/value
Data format	<ul style="list-style-type: none"> ▪ 8 data bits ▪ Parity EVEN / ODD / NONE ▪ 1 stop bit
Modbus address	ID #1 to #247 selectable (ID #17 = factory setting)

- ✓ The mains voltage at the site has been verified against the data on the name plate.
- ✓ The pump set has been de-energised and secured against unintentional start-up.
- ✓ The wiring diagram is on hand.
 1. Unscrew the cable glands (IPX4D).
 2. Undo and store the 2 screws of the cover of the terminal wiring compartment.
 3. Remove the cover of the terminal wiring compartment.
 4. Knock out and remove the closing disc of the required cable gland with a suitable tool (e.g. screwdriver).
 5. Wire a suitable bus cable to the terminal pair of the three-piece Modbus terminal and connect it to earth.
 - ⇒ The terminals are suitable for a core cross-section of up to 1.5 mm².
 6. Fit the cover of the terminal wiring compartment. Fasten it with the 2 screws.
 7. Tighten the cable glands (IPX4D).

Connection to the Modbus master

Connect all pump sets to a Modbus master. The Modbus master controls the bus communication and sends telegrams to the connected pump sets. All pump sets are slaves and only respond to the Modbus master. The pump sets do not send telegrams by themselves. Each pump set is assigned its own unique address at the time of commissioning.

Use a Modbus network cable or a cable with a defined impedance (e.g. Ethernet cable) to prevent signal losses in the electric cable. System-specific signal losses occur, for example, in the event of a failure of communication between Modbus master and pump set.

1. Remove the cover of the terminal wiring compartment.
2. Connect a suitable Modbus network cable to terminals D+ and D- of the three-piece Modbus terminal. Terminal 0 V is connected to earth at the pump end. E.g. for connecting the bus cable shield.

Terminating the Modbus data line (hardware)

Terminate both ends of the Modbus network cable with a 120 Ω resistor. Enable both DIP switches for this purpose.

The impedance of the Modbus network cable used corresponds to the terminating resistor.

Example:

Terminating resistor = 120 Ω
Impedance of network cable = 120 Ω

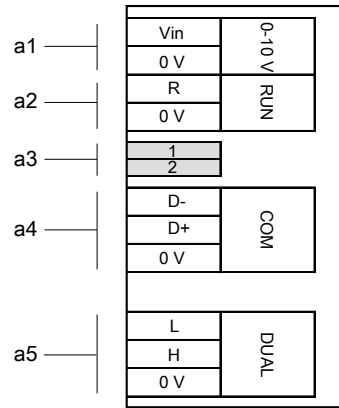

Fig. 14: Terminal wiring diagram for the Modbus data line

a	Data line connections
a1	External 0 - 10 V
a2	Remote ON/OFF
a3	Terminating resistor for Modbus cable (DIP switches)
a4	Modbus or KSB ServiceTool
a5	Dual-pump configuration

The terminating resistor is enabled when the corresponding pump-integrated DIP switch in the terminal wiring compartment next to the Modbus terminal pair is enabled. See illustration.

Table 9: Key to the terminal codes

Terminal code	Description	
	RS485	Modbus
D-	A-	D0
D+	B+	D1
0 V	COM	COM

Table 10: Settings of Modbus terminating resistors

Position of DIP switches 1 and 2	Status
ON	Modbus terminating resistor enabled
OFF	Modbus terminating resistor disabled

NOTE

The two DIP switches 1 and 2 must both be set to the same status.

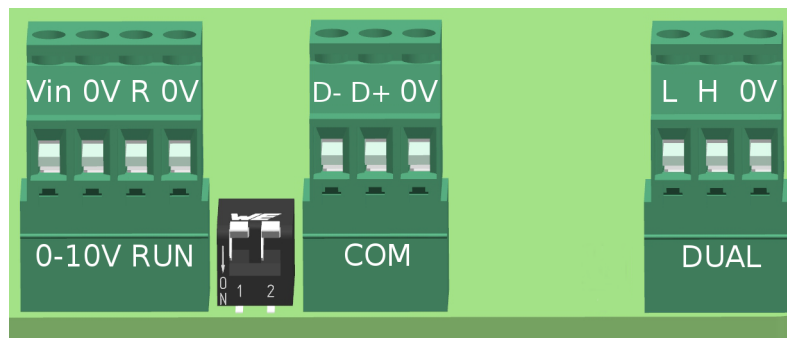

Fig. 15: Illustration of terminals

5.6.1.7 Connecting dual-pump configurations

Wire the two pumps to each other with a suitable network cable (wave impedance 120 Ω), via the terminal pairs DUAL (a5).

Setting

Make sure the settings and wiring of both pumps are identical to ensure that the changeover from duty pump to stand-by pump will not have any impact on the duty point and operating mode. Connect the control modules of the two pumps with a commercial, shielded data cable. The terminals of the RUN terminal pair must be bridged at both pumps.

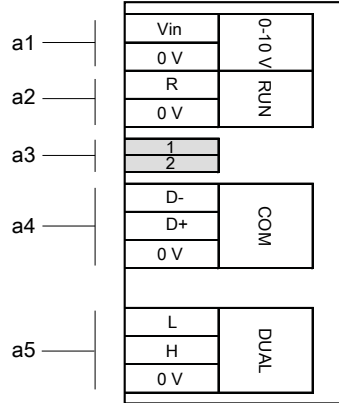

Fig. 16: Terminal wiring diagram for dual-pump configuration

a	Data line connections
a1	External 0 - 10 V
a2	Remote ON/OFF
a3	Terminating resistor for Modbus cable (DIP switches)
a4	Modbus
a5	Dual-pump configuration

6 Commissioning/Start-up/Shutdown



6.1 Commissioning/Start-up

6.1.1 Prerequisites for commissioning/start-up

Before commissioning/starting up the pump set, make sure that the following conditions are met:





- The pump set has been properly connected to the power supply and is equipped with all protection devices. (⇒ Section 5.6, Page 23)
- The system piping has been cleaned.
- The suction line and inlet tank, if any, have been primed with the fluid to be handled.
- The covers of the terminal wiring compartments have been closed and fastened with screws.

6.1.2 Priming and venting the pump

	<p>! DANGER</p>
	<p>Non-compliance with the permissible pressure and temperature limits if the pump is operated with the suction and discharge lines closed.</p> <p>Hot fluids escaping!</p> <ul style="list-style-type: none"> ▷ Never operate the pump with the shut-off elements in the suction line and/or discharge line closed. ▷ Only start up the pump set against a slightly or completely open discharge-side shut-off element.
	<p>CAUTION</p>
	<p>Increased wear due to dry running</p> <p>Damage to the pump set!</p> <ul style="list-style-type: none"> ▷ Never operate the pump set without liquid fill. ▷ Never close the shut-off element in the suction line and/or supply line during pump operation. ▷ Observe the specified minimum pressure for operating the pump set. ▷ Always operate the pump set within the permissible operating range.
	<p>NOTE</p>
	<p>The pump is self-venting.</p>

1. Fully open the shut-off elements in the suction line.
2. Slightly or fully open the shut-off element in the discharge line.

6.1.3 Start-up

	<p style="background-color: #e67e22; color: white; padding: 5px;">⚠ DANGER</p> <p>Non-compliance with the permissible pressure and temperature limits if the pump is operated with the suction and discharge lines closed. Hot fluids escaping!</p> <ul style="list-style-type: none"> ▸ Never operate the pump with the shut-off elements in the suction line and/or discharge line closed. ▸ Only start up the pump set against a slightly or completely open discharge-side shut-off element.
	<p style="background-color: #e67e22; color: white; padding: 5px;">⚠ DANGER</p> <p>Excessive temperatures due to insufficient lubrication of the plain bearings Damage to the pump set!</p> <ul style="list-style-type: none"> ▸ Never operate the pump set without liquid fill. ▸ Prime the pump as per operating instructions. ▸ Always operate the pump within the permissible operating range.
	<p style="background-color: #f1c40f; padding: 5px;">⚠ WARNING</p> <p>Hot surfaces - Pump and piping take on the temperature of the fluid handled. Risk of burns!</p> <ul style="list-style-type: none"> ▸ Do not touch hot surfaces.
	<p style="background-color: #f1c40f; padding: 5px;">CAUTION</p> <p>Abnormal noises, vibrations, temperatures or leakage Damage to the pump!</p> <ul style="list-style-type: none"> ▸ Switch off the pump (set) immediately. ▸ Eliminate the causes before returning the pump set to service.

- ✓ The system piping has been cleaned.
- ✓ Pump, suction line and inlet tank (if fitted) have been vented and primed with the fluid to be handled.
- ✓ The priming lines and venting lines have been closed.
 1. Fully open the shut-off element in the suction head line/suction lift line.
 2. Close or slightly open the shut-off element in the discharge line.
 3. Start up the motor.

6.2 Operating limits

	DANGER
	<p>Non-compliance with operating limits for pressure, temperature, fluid handled and speed Hot fluids escaping!</p> <ul style="list-style-type: none"> ▷ Comply with the operating data indicated in the data sheet. ▷ Avoid prolonged operation against a closed shut-off element. ▷ Never operate the pump at product temperatures exceeding those specified in the data sheet or on the name plate.

6.2.1 Frequency of starts

	CAUTION
	<p>Excessively high frequency of starts Damage to the pump set!</p> <ul style="list-style-type: none"> ▷ Do not exceed the values for the frequency of starts.

Maximum 20 starts per hour via the power supply.

6.2.2 Ambient temperature

	CAUTION
	<p>Operation outside the permissible ambient temperature Damage to the pump (set)!</p> <ul style="list-style-type: none"> ▷ Observe the specified limits for permissible ambient temperatures.

Observe the following parameters and values during operation:

Table 11: Permissible ambient temperatures specified for the fluid temperature

Fluid temperature	Permissible ambient temperature
[°C]	[°C]
≤ +90	+40
> +90	+30

6.2.3 Minimum inlet pressure

The minimum inlet pressure p_{\min} at the pump suction nozzle serves to avoid cavitation noises at an ambient temperature of +40 °C and the indicated fluid temperature T_{\max} .

The indicated values are applicable up to 300 m above sea level. For installation at altitudes > 300 m, an allowance of 0.01 bar / 100 m must be added.

Table 12: Minimum inlet pressure p_{\min} specified for the fluid temperature T_{\max} .

Fluid temperature	Minimum inlet pressure
[°C]	[bar]
≤ 80	0,5
81 to 95	1,5
96 to 110	2,5

6.2.4 Maximum operating pressure

	CAUTION
	<p>Permissible operating pressure exceeded Damage to connections and seals!</p> <ul style="list-style-type: none"> ▶ Never exceed the operating pressure specified in the data sheet.

The maximum operating pressure equals 6, 10 or 16 bar, depending on the design variant. See name plate (⇒ Section 4.4, Page 15)

6.2.5 Fluid handled

6.2.5.1 Permissible fluids

	! DANGER
	<p>Use for drinking water or foodstuff applications Danger of poisoning!</p> <ul style="list-style-type: none"> ▶ Never use the pump for drinking water or foodstuff applications.

	CAUTION
	<p>Unsuitable fluids Damage to the pump!</p> <ul style="list-style-type: none"> ▶ Never use the pump to handle corrosive, combustible or explosive fluids. ▶ Never use the pump to handle waste water or abrasive fluids. ▶ Do not use the pump for foodstuff applications.

- Heating water to VDI 2035
- Higher-viscosity fluids (water/glycol mixture up to a mixing ratio of 1:1)

6.2.5.2 Density of the fluid handled

	CAUTION
	<p>Impermissibly high density of the fluid handled Motor overload!</p> <ul style="list-style-type: none"> ▶ Observe the information on fluid density in the data sheet.

The power input of the pump set will change in proportion to the density of the fluid handled.

6.2.5.3 Fluid temperature

	CAUTION
	<p>Incorrect fluid temperature Damage to the pump (set)!</p> <ul style="list-style-type: none"> ▶ Only operate the pump (set) within the temperature limits indicated.

Table 13: Temperature limits of the fluid handled

Permissible fluid temperature	Value
Maximum	110 °C
Minimum	-10 °C

The fluid temperature has an impact on the minimum inlet pressure.
 (⇒ Section 6.2.3, Page 35)

6.3 Shutdown/storage/preservation

6.3.1 Shutdown

	NOTE
	<p>If the discharge line is equipped with a non-return or check valve, the shut-off element may remain open provided that the system conditions and system regulations are considered and observed.</p>

- ✓ The shut-off element in the suction line is and remains open.
 1. Close the shut-off element in the discharge line.
 2. Switch off the motor and make sure the pump set runs down smoothly to a standstill.

For prolonged shutdown periods

	CAUTION
	<p>Risk of freezing during prolonged pump shutdown periods Damage to the pump!</p> <ul style="list-style-type: none"> ▷ Drain the pump and the cooling/heating chambers (if any) or otherwise protect them against freezing.

1. Close the shut-off element in the suction line.

6.3.2 Measures to be taken for shutdown

The pump (set) remains installed

- ✓ Sufficient fluid is supplied for the functional check run of the pump.
 1. For prolonged shutdown periods, start up the pump (set) regularly between once a month and once every three months for approximately five minutes.
 - ⇒ This will prevent the formation of deposits within the pump and the pump intake area.

The pump (set) is removed from the pipe and stored

- ✓ The pump has been drained properly (⇒ Section 8.2, Page 64) and the safety instructions for dismantling the pump have been observed.
 1. Observe any additional instructions and information provided. (⇒ Section 3, Page 11)

6.4 Returning to service

	WARNING
	<p>Failure to re-install or re-activate protective devices Risk of injury from moving parts or escaping fluid!</p> <ul style="list-style-type: none"> ▷ As soon as the work is completed, properly re-install and re-activate any safety-relevant devices and protective devices.

For returning the equipment to service, observe the sections on commissioning/start-up (⇒ Section 6.1, Page 33) and the operating limits (⇒ Section 6.2, Page 35) .

In addition, carry out all servicing/maintenance operations before returning the pump (set) to service. (⇒ Section 8, Page 64)

7 Operation

7.1 Control panel

All settings are made using the control element on the housing front. The control element consists of a dial and a control button. The control button is arranged in the middle of the dial and can be pressed down. Setpoint values can be adjusted by turning the dial in increments down to a minimum of 0 %. The setpoint value is shown as a numerical value on the display. 10 LED segments are arranged around the dial. These segments represent setpoint values ranging from 0 - 100 % in increments of 10 %. The LED segments light up in blue when settings are being made at the pump. In the following example the setpoint = 40 %.

	NOTE
<p>If set to 100 %, the performance limits may cause the actual value to be slightly below the maximum characteristic curve, depending on the pump and operating point.</p>	

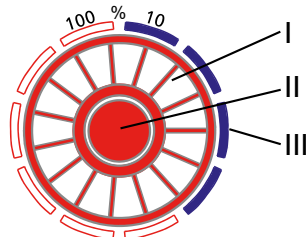

Fig. 17: Control element

I	Dial
II	Control button
III	10 LED segments (lit up in blue when pump settings are being made)

Settings overview

Table 14: Overview of settings using the control button

Menu	Time to open the corresponding menu	Details
Operating modes	Press and hold the control button for 3 seconds.	(⇒ Section 7.2, Page 40)
Functions	Press and hold the control button for 5 seconds.	(⇒ Section 7.3, Page 49)
Additional functions ³⁾	Press and hold the control button for 10 seconds.	(⇒ Section 7.4, Page 59)
Resetting to factory settings	Press and hold the control button for 30 seconds.	(⇒ Section 7.5, Page 63)

3) Depending on the model / firmware version

7.1.1 Display

The flow rate, the electrical input power and the head are shown as 3-digit numbers on the integrated display. The display alternates in 5-second intervals between these values with the corresponding units. The flow rate and the head are displayed as numbers with one decimal place; the power input is displayed as a number without any decimal places. The setpoint is indicated in [%] without any decimal places.



Fig. 18: Display

Symbols

The symbols on the front panel indicate operating modes and settings. A lit symbol signifies:

- The active operating mode
- An external 0 - 10 V signal
- A general fault message

Table 15: Symbols key

Symbol	Description	Unit
m ³ /h	Calculated flow rate <ul style="list-style-type: none"> ▪ Symbol lights up. ▪ Display shows the flow rate. 	m ³ /h
W	Measured electrical input power <ul style="list-style-type: none"> ▪ Symbol lights up. ▪ Display shows the electrical power. 	W
m	Calculated head	mWC
	Constant-pressure Control operating mode <ul style="list-style-type: none"> ▪ Symbol lights up when this operating mode is active. 	-
	Proportional-pressure Control operating mode <ul style="list-style-type: none"> ▪ Symbol lights up in blue when this operating mode is active. 	-
	Open-loop Control operating mode <ul style="list-style-type: none"> ▪ Symbol lights up when this operating mode is active. 	-
	Eco Mode (energy-saving operating mode) <ul style="list-style-type: none"> ▪ Symbol lights up in green when this operating mode is active. 	-
ECO	Dynamic Control function <ul style="list-style-type: none"> ▪ Symbol lights up in green when this function is active. 	-
0 - 10 V	0 - 10 V operating mode <ul style="list-style-type: none"> ▪ Symbol lights up when this operating mode is active. ▪ Symbol flashes when this operating mode sends a stop command. E.g. voltage signal < 1.5 V. 	VDC
MODBUS	Modbus operating mode <ul style="list-style-type: none"> ▪ Symbol lights up when this operating mode is active. ▪ Symbol flashes when this operating mode sends a stop command. 	-

Symbol	Description	Unit
DUAL	Dual-pump Operation operating mode <ul style="list-style-type: none"> ▪ Symbol lights up when this operating mode is active. ▪ Symbol flashes when this operating mode sends a stop command. 	-
SERVICE	General fault message <ul style="list-style-type: none"> ▪ An error code (E01 - E08) is shown on the display. 	-

7.2 Operating modes

7.2.1 Information about settings

The pump set is fitted with a hydraulic controller for setting the head setpoint, based on which the pump set's speed is calculated and adjusted. The head setpoint is determined by the set operating mode and the selected setpoint. The functionality of the hydraulic controller and its settings via the KSB ServiceTool are described in the KSB ServiceTool supplementary operating manual (reference number 1157.801).

For common applications such as two-pipe systems Proportional-pressure Control ($\Delta p-v$) is the recommended operating mode. This operating mode offers an extended control range with additional potential savings compared to Constant-pressure Control ($\Delta p-c$). Depending on the balancing of branch circuits, undersupply may occur at a consumer installation.

The Constant-pressure Control operating mode ($\Delta p-c$) can be selected as an option (e.g. for underfloor heating systems). If noises are audible at low flow rates, select the Proportional-pressure Control operating mode ($\Delta p-v$).

The setting of the head setpoint depends on the piping curve of the system and on the heat requirements. As standard the pump sets are set to Proportional-pressure Control ($\Delta p-v$) and medium output (setpoint 50 %).

7.2.2 Constant-pressure control

Application

- Underfloor heating systems
- Solar pumps

Solar pumps require a high operating pressure to pump sufficient fluid through the heat exchanger. Proportional-pressure Control is not necessary as the thermostatic valves do not impact on the characteristic curve.

Function

In Constant-pressure Control the set head ② is maintained irrespective of the flow rate. The set differential pressure setpoint H_s is constant, situated between the maximum curve ① and the permissible flow rate range.

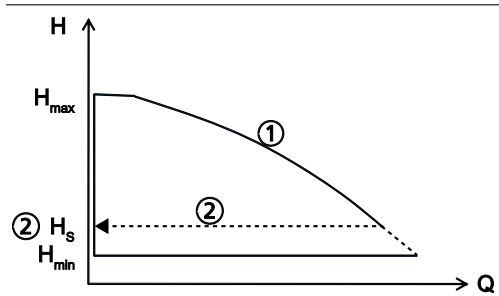



Fig. 19: Constant-pressure Control function

Setting

Press the control button to activate the display from idle mode. The display will show the current operating mode as well as, in alternation, the electrical input power and the flow rate. If 5 minutes pass without any settings being made or the control button being pressed, the display will revert to idle mode.

Table 16: Selecting Constant-pressure Control and the setpoint

	<p>Step 1: Activating the setting mode</p> <ul style="list-style-type: none"> ▪ Press and hold the control button for 3 seconds. <ul style="list-style-type: none"> – The operating mode which has last been selected will start flashing.
	<p>Step 2: Selecting the constant-pressure control operating mode</p> <ul style="list-style-type: none"> ▪ Turn the dial and select the required operating mode. ▪ The symbol will light up.
	<p>Step 3: Activating the Constant-pressure Control operating mode</p> <ul style="list-style-type: none"> ▪ Press the control button. <ul style="list-style-type: none"> – The number of flashing LED segments shows the setpoint which has last been set.

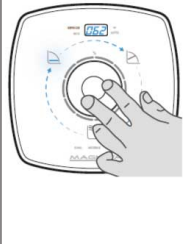
	<p>Step 4 a: Confirming the current setpoint</p> <ul style="list-style-type: none"> ▪ Press the control button.
	<p>Step 4 b: Changing the setpoint</p> <ul style="list-style-type: none"> ▪ Turn the dial and set the required setpoint in increments of 1 % within the range from 0 % to 100 %. <ul style="list-style-type: none"> – Turning it clockwise increases the setpoint; turning it anti-clockwise decreases the setpoint. – The LED segments will light up in increments of 10 %. ▪ Press the control button to save the setpoint.

	<p>NOTE</p> <p>If 10 seconds pass without any settings being made or saved, the control unit will revert to the previous settings.</p>
---	---

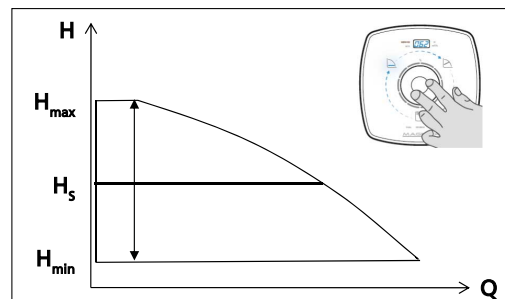



Fig. 20: Constant-pressure Control settings

	<p>NOTE</p> <p>To start the pump the "RUN" terminal pair must be bridged (factory setting) or the terminal pair must receive the START signal.</p>
---	---

7.2.3 Proportional-pressure control

Application

- Heating systems with a radiator

The higher the flow rate, the higher the system's resistance. This is corrected by the pump set automatically increasing the head setpoint.

When setting the setpoint ensure that the selected control curve is suitable for the system characteristic curve:

- If the system characteristic curve is known (e.g. hydraulic balancing), select a control curve that is minimally above the characteristic curve. See type series booklet.
 - Control curve too low: undersupply
 - Control curve too high: increased energy input
- If the system characteristic curve is unknown, dynamic control is recommended. (⇒ Section 7.4.3, Page 61)
 - The pump set automatically recognises the system characteristic curve via the speed control system and optimises the operating point accordingly.

Function

Within the permissible flow rate range the Proportional-pressure Control decreases or increases the differential pressure setpoint between $\frac{1}{2} H_s$ and H_s (factory setting).

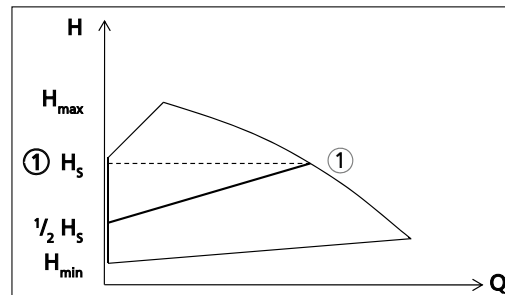



Fig. 21: Proportional-pressure Control function

Setting

Press the control button to activate the display from idle mode. The display will show the current operating mode as well as, in alternation, the electrical input power and the flow rate. If 5 minutes pass without any settings being made or the control button being pressed, the display will revert to idle mode.

Table 17: Selecting Proportional-pressure Control and the setpoint

	<p>Step 1: Activating the setting mode</p> <ul style="list-style-type: none"> ▪ Press and hold the control button for 3 seconds. <ul style="list-style-type: none"> – The operating mode which has last been selected will start flashing.
	<p>Step 2: Selecting the Proportional-pressure Control operating mode</p> <ul style="list-style-type: none"> ▪ Turn the dial and select the required operating mode. ▪ The symbol lights up in blue.
	<p>Step 3: Activating the Proportional-pressure Control operating mode</p> <ul style="list-style-type: none"> ▪ Press the control button. <ul style="list-style-type: none"> – The number of flashing LED segments shows the setpoint which has last been set.

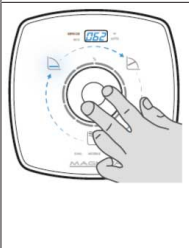
	<p>Step 4 a: Confirming the current setpoint</p> <ul style="list-style-type: none"> ▪ Press the control button.
	<p>Step 4 b: Changing the setpoint</p> <ul style="list-style-type: none"> ▪ Turn the dial and set the required setpoint in increments of 1 % within the range from 0 % to 100 %. <ul style="list-style-type: none"> – Turning it clockwise increases the setpoint; turning it anti-clockwise decreases the setpoint. – The LED segments will light up in increments of 10 %. ▪ Press the control button to save the setpoint.

	<p>NOTE</p> <p>If 10 seconds pass without any settings being made or saved, the control unit will revert to the previous settings.</p>
---	---

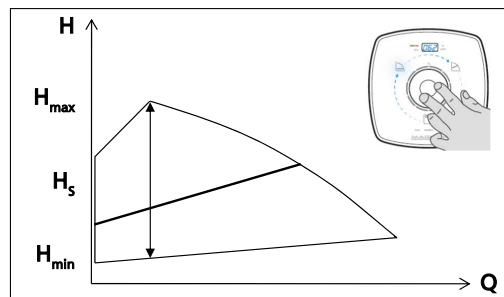



Fig. 22: Proportional-pressure Control settings

	<p>NOTE</p> <p>To start the pump the "RUN" terminal pair must be bridged (factory setting) or the terminal pair must receive the START signal.</p>
---	---

7.2.4 Eco Mode

Function

Eco Mode operating mode is an energy-efficient alternative to Proportional-pressure Control. Eco Mode is based on a linear characteristic curve rather than a quadratic one. The consequences on the process are illustrated at the example of size 25-100 in the figure below:

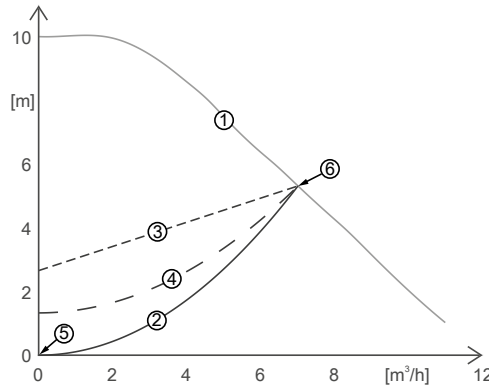

Fig. 23: Eco Mode and proportional pressure, example of a size 25-100 pump

1	Maximum operating range	4	Eco Mode characteristic curve (setpoint 50 %)
2	System characteristic curve	5	Origin
3	Proportional-pressure Control characteristic curve	6	Maximum characteristic curve

From a physical point of view, the system characteristic curve (2) is always a parabola through the origin (5) of the coordinate system. When selecting the setpoint make sure that the intersection of the maximum operating range (1) and the characteristic curve of the selected control mode (3)/(4) is above or on the system characteristic curve (2). This prevents undersupply. If, at the same setpoint, the Eco Mode operating mode is selected, the Eco Mode characteristic curve (4) is a parabola instead of a straight line. The characteristic curves of both Eco Mode and Proportional-pressure Control intersect the maximum characteristic curve (6) in the same point. At zero flow rate the set head in Eco Mode is 50 % lower than in Proportional-pressure Control operating mode. The system characteristic curve (2) always passes through the origin (5); it is a parabola, like the characteristic curve of the Eco Mode (4). This ensures sufficient supply over the entire operating range and markedly reduces the power input. We recommend using Eco Mode rather than Proportional-pressure Control. This results in power savings of a maximum of 53 % and an average of 36 %. The power savings are illustrated in the figure below:

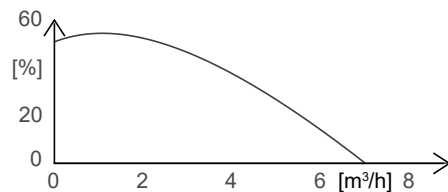

Fig. 24: Savings potential of Eco Mode compared to Proportional-pressure Control at the example of a size 25-100 pump

Setting

Press the control button to activate the display from idle mode. The display will show the current operating mode as well as, in alternation, the electrical input power and the flow rate. If 5 minutes pass without any settings being made or the control button being pressed, the display will revert to idle mode.

Table 18: Selecting Eco Mode and the setpoint

	<p>Step 1: Activating the setting mode</p> <ul style="list-style-type: none"> Press and hold the control button for 3 seconds. <ul style="list-style-type: none"> The operating mode which has last been selected will start flashing.
	<p>Step 2: Selecting the Eco Mode operating mode</p> <ul style="list-style-type: none"> Turn the dial and select the required operating mode. The symbol lights up in green.
	<p>Step 3: Activating the Eco Mode operating mode</p> <ul style="list-style-type: none"> Press the control button. <ul style="list-style-type: none"> The number of flashing LED segments shows the setpoint which has last been set.
	<p>Step 4 a: Confirming the current setpoint</p> <ul style="list-style-type: none"> Press the control button.
	<p>Step 4 b: Changing the setpoint</p> <ul style="list-style-type: none"> Turn the dial and set the required setpoint in increments of 1 % within the range from 0 % to 100 %. <ul style="list-style-type: none"> Turning it clockwise increases the setpoint; turning it anti-clockwise decreases the setpoint. The LED segments will light up in increments of 10 %. Press the control button to save the setpoint.

	<p>NOTE</p>
	<p>If 10 seconds pass without any settings being made or saved, the control unit will revert to the previous settings.</p>

	<p>NOTE</p>
	<p>To start the pump the "RUN" terminal pair must be bridged (factory setting) or the terminal pair must receive the START signal.</p>

7.2.5 Open-loop control

Function

In Open-loop Control operating mode the pump runs at a set speed. The speed can be set to one of 100 speed levels.

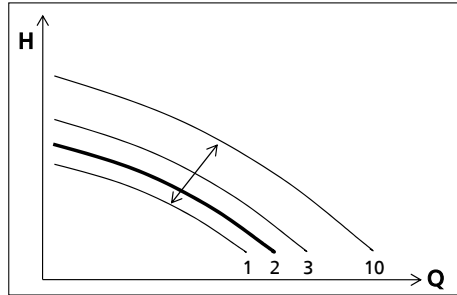

Fig. 25: Open-loop Control function, running at speed level 2

Setting

Press the control element to activate the display from idle mode. The display will show the current operating mode as well as, in alternation, the electrical input power and the flow rate. If 5 minutes pass without any settings being made or the control button being pressed, the display will revert to idle mode.

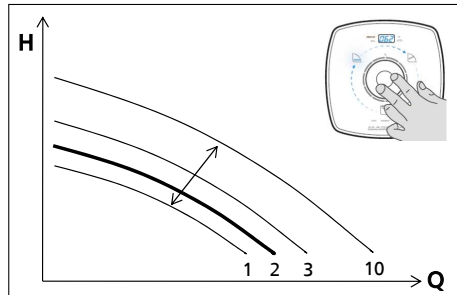

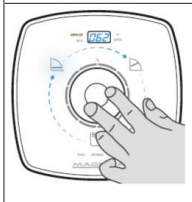



Fig. 26: Open-loop Control settings

Table 19: Selecting Open-loop Control and the setpoint

	<p>Step 1: Activating the setting mode</p> <ul style="list-style-type: none"> Press the control element for 3 seconds. <ul style="list-style-type: none"> The operating mode which has last been selected will start flashing. 
	<p>Step 2: Selecting the Open-loop Control operating mode</p> <ul style="list-style-type: none"> Turn the control element and select the required operating mode. 
	<p>Step 3: Activating the Open-loop Control operating mode</p> <ul style="list-style-type: none"> Press the control element. <ul style="list-style-type: none"> The number of flashing LED segments shows the setpoint which has last been set.

	<p>Step 4 a: Confirming the current setpoint</p> <ul style="list-style-type: none"> ▪ Press the control element.
	<p>Step 4 b: Changing the setpoint</p> <ul style="list-style-type: none"> ▪ Turn the control element and set the required setpoint in increments of 1 % within the range from 0 % to 100 %. <ul style="list-style-type: none"> – Turning it clockwise increases the setpoint; turning it anti-clockwise decreases the setpoint. – The LED segments will light up in increments of 10 %. ▪ Press the control element to save the setpoint.

	NOTE
	<p>If 10 seconds pass without any settings being made or saved, the control unit will revert to the previous settings.</p>
	NOTE
	<p>To start the pump the "RUN" terminal pair must be bridged (factory setting) or the terminal pair must receive the START signal.</p>

Table 20: Speeds

Size	Speed	
	Minimum speed Setpoint input 0 %	Maximum speed Setpoint input 100 %
	[rpm]	[rpm]
30-60	1000	3500
30-100	1000	4500
32-80	1000	4000
32-120	1000	4000
40-80	1000	3600
40-100	1000	4000
40-120	1000	2900
40-180	1000	3500
50-80	1000	3500
50-100	1000	2750
50-120	1000	2930
65-80	1000	2850
65-120	1000	3200
65-120	1000	3200

7.2.6 Temperature-governed differential pressure control

The temperature-governed differential pressure control increases or decreases the head in a linear fashion with the fluid temperature. The operating mode can be activated via the KSB ServiceTool. The functionality of the temperature-governed differential pressure control and its settings are described in the KSB ServiceTool supplementary operating manual (reference number 1157.801).

1157.841/06-EN

7.3 Functions

7.3.1 Remote ON/OFF (digital input)

	CAUTION
	<p>External voltage applied to the RUN terminal Damage to the printed circuit board!</p> <ul style="list-style-type: none"> ▸ Always use a volt-free contact for the RUN terminal.

	CAUTION
	<p>Using digital inputs for safety-relevant shutdown Pump does not stop! Damage to the electronics!</p> <ul style="list-style-type: none"> ▸ For safety-related shutdown always separate the unit from the power supply network (e.g. by installing an Emergency OFF system).

The digital input is factory-set to start up and stop the pump set.
 The digital input can also be configured. For the configuration use the KSB ServiceTool as described in the KSB ServiceTool supplementary operating manual (reference number 1157.801).

Table 21: Pump start and stop

Contact	Response
Contact closed / terminals bridged	Pump set starts up.
Contact open / terminals not bridged	Pump set stops.

7.3.2 External analog 0 - 10 V DC signal

	CAUTION
	<p>External voltage applied to the RUN terminal Damage to the printed circuit board!</p> <ul style="list-style-type: none"> ▸ Always use a volt-free contact for the RUN terminal.

Function

An external analog 0 - 10 V DC signal serves as setpoint input. If the Constant-pressure Control, Proportional-pressure Control or Eco Mode operating modes are active, the pump set processes the current external analog signal as a setpoint. If the Open-loop Control operating mode is active, the pump set processes the external analog signal as a speed setpoint. If the signal level < 1.5 V DC, the pump will stop and the last LED segment will extinguish.

Table 22: Setpoint settings at the pump for signal level 0 - 10 V

Signal level	Setpoint input at the pump set
10 V DC	100 % of the setpoint
2 V DC	0 % of the setpoint
< 1,5 V DC	Pump stops.
≥ 2 V DC	Pump starts up.

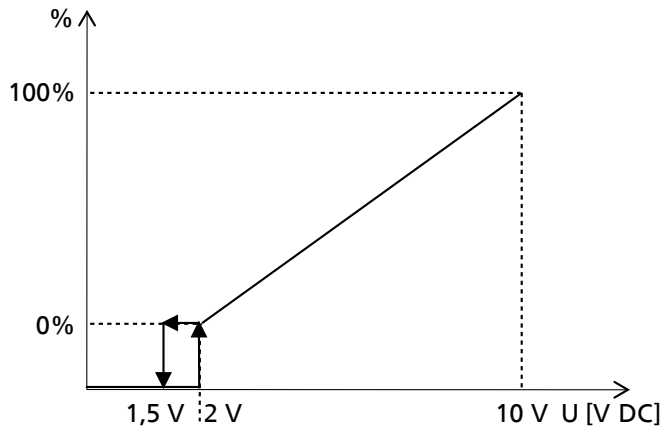

Fig. 27: Analog 0 - 10 V signal as setpoint input for the pump set

Use the KSB ServiceTool for setting the limits and parameters for the following functions:

- Starting up the pump
- Stopping the pump
- Monitoring for broken wires
- Pump set behaviour in the event of a broken wire

The analog input can also be configured as an input for actual values (differential pressure, fluid temperature). The settings for the analog input are described in the KSB ServiceTool supplementary operating manual (reference number 1157.801).

Setting

Press the control element to activate the display from idle mode. The display will show the current operating mode as well as, in alternation, the electrical input power and the flow rate. If 5 minutes pass without any settings being made or the control button being pressed, the display will revert to idle mode.

Table 23: Starting and stopping 0 - 10 V

	<p>Step 1: Activating the functions (DUAL, Modbus, 0 - 10 V) setting mode</p> <ul style="list-style-type: none"> ▪ Press and hold the control button for 6 seconds. <ul style="list-style-type: none"> – The functions setting mode is active.
	<p>Step 2: Selecting 0 - 10 V</p> <ul style="list-style-type: none"> ▪ Turn the dial and select the required function. ▪ The symbol will light up. <p>0 - 10 V</p>
	<p>Step 3: Activating/disabling 0 - 10 V</p> <ul style="list-style-type: none"> ▪ Press the control button. <ul style="list-style-type: none"> – When the signal is activated, the circular segments will indicate the value of the input signal.

	NOTE
If 10 seconds pass without any settings being made or saved, the control unit will revert to the previous settings.	

Table 24: Number of lit LED segments assigned to electrical voltage

Number of lit LED segments	Electrical voltage [V]
0	2,4
1	3,2
2	4,0
3	4,8
4	5,6
5	6,4
6	7,2
7	8,0
8	8,8
9	9,6
10	10,0

	NOTE
	To start the pump the "RUN" terminal pair must be bridged (factory setting) or the terminal pair must receive the START signal.

7.3.3 Dual-pump operation (DUAL)

Function

Activating the DUAL function starts dual-pump operation. After a few seconds, the duty/stand-by operating mode becomes active and will stop one of the pumps. The pump which remains active (on duty) is operated at 0 - 100 %; the other pump is on stand-by.

The remote ON/OFF function is de-activated for the stand-by pump, irrespective of the wiring of the RUN terminal pair. The duty pump can be controlled by means of the 0 - 10 V operating mode or the integrated remote ON/OFF function.

Automatic pump changeover The pump sets come with an integrated timer that stops the duty pump set after 24 hours of operation and starts up the stand-by pump. To this effect, before the duty pump is stopped it signals a start command to the stand-by pump. The stand-by pump will be started up and the first pump will be stopped.

Redundant operation In the event of a failure of the duty pump the stand-by pump will be started up automatically and will take over the function of the failed pump. The pump changeover function and the redundant operation function are performed automatically.

Peak load In Peak Load function either one pump set is running in redundant operation or two pump sets are running in parallel. A second pump set is started up in the following cases:

- The overall efficiency of the system with two pump sets running in parallel is higher than with a single pump running.
- The set head is not reached by one pump alone.

The Peak Load function is described in the KSB ServiceTool supplementary operating manual (reference number 1157.801).

Setting

Press the control element to activate the display from idle mode. The display will show the current operating mode as well as, in alternation, the electrical input power and the flow rate. If 5 minutes pass without any settings being made or the control button being pressed, the display will revert to idle mode.

	NOTE
	Connected pump sets will use the settings of the other pump sets. This does not apply to the Modbus address.

Table 25: Activating and de-activating the Dual-pump Operation (DUAL) operating mode

	<p>Step 1: Activating the functions (DUAL, Modbus, 0 - 10 V) setting mode</p> <ul style="list-style-type: none"> ▪ Press and hold the control button for 6 seconds. <ul style="list-style-type: none"> – The functions setting mode is active.
	<p>Step 2: Selecting Dual-pump Operation (DUAL)</p> <ul style="list-style-type: none"> ▪ Turn the dial and select the required function. ▪ The symbol will light up. <p>DUAL</p>
	<p>Step 3: Activating or de-activating Dual-pump Operation (DUAL)</p> <ul style="list-style-type: none"> ▪ Press the control button.

	<p>NOTE</p> <p>If 10 seconds pass without any settings being made or saved, the control unit will revert to the previous settings.</p>
--	---

7.3.4 Modbus

Function

All pump sets are slaves; they only respond to the Modbus master (external hardware and software).

The pump set can neither be set nor operated as a Modbus master.

The send commands and receive commands comply with the requirements of the Modbus RTU standard protocol.

	<p>NOTE</p> <p>All Modbus data points can only be read (monitored) and input transmitted via Modbus can only be received and processed when Modbus is activated. See Overview of Modbus operating parameters.</p>
--	--

Table 26: Overview of Modbus operating parameters

Parameter description	Register	Length [byte]	Type/format	Unit	Access
Error value, bit code	07 D0	00 02	UINT16	Bit 0 = error code E01 Bit 1 = error code E02 Bit 2 = error code E03 Bit 3 = error code E04 Bit 4 = error code E05 Bit 5 = error code E06 Bit 6 = error code E07 Bit 7 = error code E08 Bit 8 = error code E09 Bit 9 = error code I10 Bit 10 = error code E11 Bit 11 = error code E12 Bit 12 = error code E13 Bit 13 = error code I14 Bit 14 = error code E15 Bit 15 = error code E16 (See error value key table.)	R
Error value 2, bit code	07 D1	00 02	UINT16	Bit 0 = error code E17 Bit 1 = error code I18 Bit 2 = error code I19 (See error value key table.)	R
Calculated head	07 D2	00 02	INT16	Head in m × 10	R
Calculated flow rate	07 D4	00 02	INT16	Flow rate in m ³ /h × 10	R
Current speed	07 D8	00 02	UINT16	Speed in rpm	R
Pump status	07 D9	00 02	UINT16	0 = Pump stop 1 = Pump in operation	R
Operating hours pump	07 DA	00 02	UINT16	Operating hours	R
Pump power	07 DC	00 02	INT16	Watt	R
Temperature power supply module (SPM)	07 DF	00 02	INT16	°C	R
Ambient temperature	07 E0	00 02	INT16	°C	R
Motor temperature	07 E1	00 02	INT16	°C	R
Temperature reactive power compensation module (PFC)	07 E2	00 02	INT16	°C	R
Fluid temperature	07 E3	00 02	INT16	°C	R
Energy meter	07 E4	00 02	UINT16	kWh	R
Flow rate meter	07 E5	00 02	UINT16	m ³	R
Setback operation status	07 E6	00 02	UINT16	0 = day 1 = night	R
Operating mode selection	08 34	00 02	ENUM	1 = Constant-pressure Control 4 = Proportional-pressure Control (factory setting) 8 = Eco Mode 16 = Open-loop Control	R/W
Setpoint input	08 35	00 02	UINT16	0 - 9999 (equals 0 - 100 % of the setpoint)	R/W
Pumps start/stop	08 36	00 02	ENUM	0×05 = pump stop 0×A0 = pump start (does not overwrite the external RUN contact)	R/W

1157.841/06-EN

Parameter description	Register	Length [byte]	Type/format	Unit	Access
Modbus baud rate	0B B8	00 02	ENUM	0 = 19,200 (factory setting) 2 = 4,800 3 = 9,600 4 = 19,200 5 = 38,400 6 = 57,600 7 = 115,200	R/W
Modbus Address	0B B9	00 02	UINT16	0 - 247, default address 17	R/W
Modbus parity	0B BA	00 02	UINT16	2 = PE: Parity Even (factory setting) 1 = PO: Parity Odd 0 = P-: No Parity	R/W

Data points

Data points of type R are read-only; data points of type R/W are read enabled & write enabled.

Table 27: Read and write data points

Function	Function code
Read	Function code 03 (0x03 Read holding registers)
Write	Function code 16 (0x10 Write multiple register)

All registers (07 D0 ... 07 DE) can be read out via function code 0x03 (Read holding registers) as one unit.

Table 28: Error value key

Error value	Description	Bit
Error value, bit code		
E01	Temperature limit exceeded	0
E02	Overcurrent	1
E03	Internal error	2
E04	Pump rotor blocked	3
E05	Temperature increase, speed decrease	4
E06	Mains voltage too high / too low	5
E07	Test alert ⁴⁾	6
E08	Motor fault	7
E09	High fluid temperature	8
E11	Broken wire NTC / speed decrease	10
E12	Firmware update required	11
E13	Pump size not selected	12
E15	Minimum flow	14
E16	Maximum flow	15
I10	Broken wire at analog input	9
I14	Both pumps programmed as "left pump"	13
Error value 2, bit code		
E17	Externally forced flow	0
I18	Externally forced flow in pumping direction	1
I19	Backflow through the pump	2

4) Further information in the KSB ServiceTool supplementary operating manual (reference number 1157.801)

	NOTE
	<p>Error values I18 and I19 serve as information; error values I10, E11 and I14 are warnings. The pump set does not stop in this case. The error value is displayed until the corresponding error has been resolved. Error value E05 reduces the speed until no overload is detected any more.</p>

Examples of Modbus communication

1. Monitoring the speed:
To be able to read the current speed of the pump set, the following request has to be sent by the Modbus master: Modbus Request 11 03 07 D8 00 01 07 D5
2. Setpoint input:
The setpoint can be set to any value from 0 - 9999 (equalling 0 - 100 % of the setpoint).
Example: Write setpoint 50 %
Modbus Request 11 10 08 35 00 01 02 13 88 EA A3
3. Input control mode:
The operating mode of the pump can also be changed via Modbus (see table).
Example: Write control mode Open-loop Control
Modbus Request 11 10 08 34 00 01 02 00 10 E7 E8

Control options of pump sets and priorities

The pump set can be controlled via the control element, Modbus or the analog input. The control options available are indicated in the table.

The pump set will start up when no alarm is active, the RUN contact is bridged, and the pump set is connected to 230 V. If the external analog 0 - 10 V signal is active, the setpoint of the analog input will be valid; all other setpoint inputs will be ignored. If the external analog 0 - 10 V signal is disabled, the last valid setpoint is valid, regardless of whether the input is made via the control element or Modbus. The operating mode can be changed at any time via Modbus or the control element; both are of the same priority.

Table 29: Symbols key

Symbol	Description
X	Setting possible
-	Setting not possible

Table 30: Setting options for the pump sets

Setting option	Operating mode	Setpoint	Start/stop
0 - 10 V	-	X	X
Modbus	X	X	X
Control element	X	X	-

If the Modbus function and the DUAL (dual-pump operation) functions are both active, either one or both of the pump sets can be connected to Modbus. Changes of global input for the duty pump set will also be transmitted to the stand-by pump set via the terminal pair DUAL. In Dual-pump Operation operating mode the following priorities apply to the setpoint input:

Table 31: Priority list

Priority	Setpoint input
1	0 - 10 V of master pump
2	0 - 10 V of slave pump
3	The last valid value input via Modbus or control element of the master pump or slave pump

The digital input (RUN terminal) is factory-set to start up and stop the pump set. If the digital input is configured for a different function, the pump set can no longer be stopped via the digital input.







	NOTE
	The pump is delivered with the terminal pair RUN bridged.

Setting

For activating/de-activating the Modbus operating mode and adjusting the Modbus communication settings, connect the pump to a Modbus network with a suitable, commercial, shielded data cable.

Press the control element to activate the display from idle mode. The display will show the current operating mode as well as, in alternation, the electrical input power and the flow rate. If 5 minutes pass without any settings being made or the control button being pressed, the display will revert to idle mode.

Table 32: Activating and de-activating the Modbus operating mode

	<p>Step 1: Activating the functions (DUAL, Modbus, 0 - 10 V) setting mode</p> <ul style="list-style-type: none"> ▪ Press and hold the control button for 6 seconds. <ul style="list-style-type: none"> – One of the symbols representing the Dual-pump operation (DUAL), Modbus and 0 - 10 V functions will start flashing.
	<p>Step 2: Selecting Modbus</p> <ul style="list-style-type: none"> ▪ Turn the dial and select the required function. <p>Modbus</p>
	<p>Step 3: Activating/disabling the setting mode</p> <ul style="list-style-type: none"> ▪ Press the control button. <ul style="list-style-type: none"> – The symbol will light up.
	<p>Step 4: Setting the Modbus address (flashing display)</p> <ul style="list-style-type: none"> ▪ Turn the dial and set the required address. ▪ Press the control button. <ul style="list-style-type: none"> – Factory setting: 17
	<p>Step 5: Setting the Modbus baud rate (flashing display)</p> <ul style="list-style-type: none"> ▪ Turn the dial and set the required baud rate. ▪ Press the control button. <ul style="list-style-type: none"> – Factory setting: 19.2
	<p>Step 6: Setting the Modbus parity (flashing display)</p> <ul style="list-style-type: none"> ▪ Turn the dial and set the parity. ▪ Press the control button. <ul style="list-style-type: none"> – Factory setting: PE (Parity Even) – PO (Parity ODD) – P- (No Parity)

	NOTE
	If 10 seconds pass without any settings being made, the entries made so far made will be saved.

7.3.5 Ramps

During normal operation the motor responds to a setpoint change of the pump controller with maximum dynamic. To prevent pressure surges this dynamic is limited while the pump set is started up / stopped or when the pump controller changes the setpoint in large increments. The ramps' dynamic is set via the KSB ServiceTool. The ramps' function and settings are described in the KSB ServiceTool supplementary operating manual (reference number 1157.801).

7.3.6 Deblocking the impeller

Function

The pump is started up at maximum torque to remove any mechanical blocking which may occur (at the impeller or motor shaft). The pump's current input is limited in this case (protective function). If the blocking cannot be removed, the pump will stop the start-up attempt, and error code E04 will be displayed. After a short interval the pump will try to start up again. The start-up attempts are limited to 24 hours. Once the pump has started up successfully, it will acknowledge the error message; error code E04 will disappear from the display.

Settings

None

7.3.7 Temperature monitoring

To protect the motor against overheating a sensor monitors the winding temperature. If the temperature enters the critical range, the motor outputs warning E05 and the maximum permissible speed is limited. The speed limit settings are described in the KSB ServiceTool supplementary operating manual (reference number 1157.801).

7.3.8 Monitoring equipment

The pump set checks that the following values are observed:

- Minimum/maximum flow rate
- Fluid temperature

The monitoring options **flow rate limit (Flow Limit)** and **high fluid temperature** can be enabled via the KSB ServiceTool. The functions and settings are described in the KSB ServiceTool supplementary operating manual (reference number 1157.801).

7.3.9 Saving data

Function

The operating data of the pump are saved. Data storage will be maintained also when the pump is stopped or de-energised. When the pump is started up again, it will be operated with the data and duty point that were active before the pump was last stopped.

Settings

None

7.3.10 General fault messages

Table 33: Error codes, causes and response





Error code on the display	Cause	Status	Response
E01	Excessive temperature	Alert	Pump stops.
E02	Overcurrent	Alert	Pump stops.
E03	Internal fault	Alert	Pump stops.
E04	Pump rotor blocked	Alert	Pump stops.
E05	Temperature limit reached	Warning	Speed is reduced.
E06	Voltage error	Alert	Pump stops.
E07	Test alert ⁵⁾	Alert	-
E08	Motor fault	Alert	Pump stops.
E09	High fluid temperature	Warning	-
E11	Broken wire of temperature sensor (NTC thermistor) in the motor	Warning	Speed is reduced.
E12	Firmware update required	Alert	Pump stops.
E13	No pump model stored	Alert	Pump stops.
E15	Minimum flow	Warning	-
E16	Maximum flow	Warning	-
E17	Externally forced flow	Alert	Pump stops.
I10	Broken wire at analog input	Information	The pump behaviour can be set via the KSB ServiceTool.
I14	For dual pumps both pumps are programmed as "left pump".	Information	Pumps keep running.
I18	Externally forced flow in pumping direction	Information	Pump keeps running.
I19	Backflow through the pump	Information	Pump keeps running.

5) Further information in the KSB ServiceTool supplementary operating manual (reference number 1157.801)

7.4 Additional functions

7.4.1 Locking the control panel

Table 34: Locking / unlocking the control panel

	<p>Step 1: Activating the additional function setting mode</p> <ul style="list-style-type: none"> ▪ Press and hold the control button for 10 seconds. <ul style="list-style-type: none"> – The additional functions setting mode is active. – The current status of the control panel is shown.
	<p>Step 2: Activating the setting mode</p> <ul style="list-style-type: none"> ▪ Press the control button. <p>H-O / H-L</p>
	<p>Step 3: Locking / unlocking the control panel</p> <ul style="list-style-type: none"> ▪ Turn the dial and select the required status. <ul style="list-style-type: none"> – H-L = control panel locked – H-O = unlock control panel
	<p>Step 4: Confirming the setting</p> <ul style="list-style-type: none"> ▪ Press the control button.

	<p>NOTE</p> <p>Only when the control panel is unlocked can operating modes and functions be set and settings be reset to factory settings.</p>
---	---

7.4.2 Setback operation

Function

When the Setback Operation function is active, the pump set identifies minimum heat demand when the fluid temperature sinks continuously. The pump set automatically reduces the setpoint. When heat demand rises again, the pump set reverts to its previous setpoint.

When the Setback Operation function is active, the pump set switches between night mode and day mode.

Night mode is active in the following cases:

- The fluid temperature sinks by 15 °C within 2 hours.

Day mode is active in the following cases:

- The fluid temperature rises by 3 °C.
- The pump set has been in night mode for more than 7 hours.

Settings

	NOTE
	<p>If the fluid temperature is input via the analog 0 - 10 V input, the pump sets have to have the same configuration and receive the same voltage signal.</p>

The Setback Operation function and its settings via the KSB ServiceTool are described in the KSB ServiceTool supplementary operating manual.

Table 35: Activating and disabling Setback Operation

	<p>Step 1: Activating the additional function setting mode</p> <ul style="list-style-type: none"> ▪ Press and hold the control button for 10 seconds. <ul style="list-style-type: none"> – The additional functions setting mode is active.
	<p>Step 2: Selecting Setback Operation</p> <ul style="list-style-type: none"> ▪ Turn the dial and select the required function. <p>nd0 / nd1</p>
	<p>Step 3: Activating the setting mode</p> <ul style="list-style-type: none"> ▪ Press the control button.
	<p>Step 4: Activating/disabling Setback Operation</p> <ul style="list-style-type: none"> ▪ Turn the dial and select the required status. <ul style="list-style-type: none"> – nd0 = Setback operation disabled – nd1 = Setback operation activated
	<p>Step 5: Confirming the setting</p> <ul style="list-style-type: none"> ▪ Press the control button.

7.4.3 Dynamic control

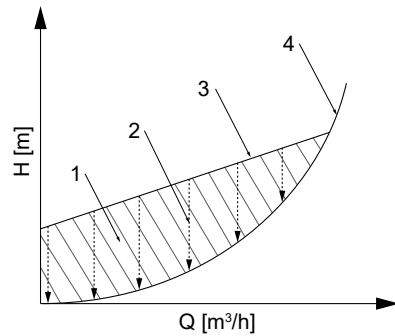

Fig. 28: Principle of dynamic control

1	Excess energy input	3	Control curve
2	Dynamic Control	4	Minimum characteristic curve

The dynamic control (2) system detects when the selected control curve (3) is higher than the minimum characteristic curve⁶⁾ (4). The control system shifts the control curve downward, and power input is reduced automatically. To ensure sufficient supply the pump set switches to a higher control curve when the minimum characteristic curve is reached. The energy input is reduced (1) without any negative impact on the supply of the building.

The pump set is operated in an optimised way, even if the system characteristic curve is unknown; the noise at the thermostatic valves is reduced.

Application

- If the system characteristic curve is known (e.g. hydraulic balancing):
 - Set the setpoint manually. Select a control curve that is minimally above the characteristic curve. See type series booklet.
 - Activating Dynamic Control in addition is recommended. Even if the setpoint has been set to an optimum, excessive throttling of the thermostatic valves may occur in certain climatic conditions. Dynamic Control will further optimise the operating point.
- If the system characteristic curve is unknown:
 - Use the standard settings and activate Dynamic Control. The pump set automatically recognises the system characteristic curve via the speed control system and optimises the operating point accordingly.





Settings

The Dynamic Control function and its settings via the KSB ServiceTool are described in the KSB ServiceTool supplementary operating manual (reference number 1157.801).

Use of Dynamic Control with basic settings:



6) Characteristic curve at fully open thermostatic valves

Table 36: Activating and disabling Dynamic Control

	<p>Step 1: Activating the additional function setting mode</p> <ul style="list-style-type: none"> ▪ Press and hold the control button for 10 seconds. <ul style="list-style-type: none"> – The additional functions setting mode is active.
	<p>Step 2: Selecting Dynamic Control</p> <ul style="list-style-type: none"> ▪ Turn the dial and select the required function. dc0 / dc1
	<p>Step 3: Activating the setting mode</p> <ul style="list-style-type: none"> ▪ Press the control button.
	<p>Step 4: Activating/disabling Dynamic Control</p> <ul style="list-style-type: none"> ▪ Turn the dial and select the required status. <ul style="list-style-type: none"> – dc0 = Dynamic Control disabled. – dc1 = Dynamic Control activated.
	<p>Step 5: Confirming the setting</p> <ul style="list-style-type: none"> ▪ Press the control button. <ul style="list-style-type: none"> – The symbol lights up in green. <p>ECO</p>

7.4.4 Information

Table 37: Displaying information

	<p>Step 1: Activating the additional function setting mode</p> <ul style="list-style-type: none"> ▪ Press and hold the control button for 10 seconds. <ul style="list-style-type: none"> – The additional functions setting mode is active.
	<p>Step 2: Selecting Information</p> <ul style="list-style-type: none"> ▪ Turn the dial and select the required function. <p>Inf</p>
	<p>Step 3: Confirming the setting</p> <ul style="list-style-type: none"> ▪ Press the control button. <ul style="list-style-type: none"> – The pump size and the current firmware version are briefly shown on the display. – The display then changes automatically to its normal operating display.

7.5 Resetting the factory setting

To reset the factory setting of the pump press the control button for more than 30 seconds.

This comprises the following settings:

Operating mode	Proportional-pressure control
Functions	The Dual, Modbus, 0 - 10 V functions are disabled.
Setpoints	50 %
Modbus parameter baud rate	19.200 Baud
Modbus parameter slave ID	17
Modbus parameter parity	Even

8 Servicing/Maintenance

8.1 Maintenance/inspection

The circulators are almost maintenance-free.
If the pump has not been in operation for a prolonged period of time or if the system is severely contaminated, the rotor can become blocked.

	NOTE
	<p>Any repairs on the pump must only be performed by one of our authorised service partners. For contact details please refer to the enclosed "Addresses" booklet or visit "www.ksb.com/contact" on the Internet.</p>

8.2 Drainage/cleaning

	! WARNING
	<p>Fluids handled, consumables and supplies which are hot and/or pose a health hazard Hazard to persons and the environment!</p> <ul style="list-style-type: none"> ▷ Collect and properly dispose of flushing fluid and any fluid residues. ▷ Wear safety clothing and a protective mask if required. ▷ Observe all legal regulations on the disposal of fluids posing a health hazard.



1. Always flush and clean the pump before transporting it to the workshop.
Provide a certificate of decontamination for the pump.

8.3 Removing the pump set from the piping

	! DANGER
	<p>Hazardous electrical voltage when the covers of the terminal wiring compartments are removed Danger of death from electric shock!</p> <ul style="list-style-type: none"> ▷ For working on the terminals, switch off the power supply at least 5 minutes prior to commencing work and ensure that it cannot be switched on again unintentionally. ▷ If applicable, switch off the external power supply to message relays and control cables and make sure it cannot be switched on again unintentionally. ▷ Keep the covers of the terminal wiring compartments closed during operation as well as during maintenance work.



	! DANGER
	<p>Strong magnetic field in the rotor area Danger of death for persons with pacemaker! Interference with magnetic data carriers, electronic devices, components and instruments! Uncontrolled magnetic attraction forces between magnet-equipped components, tools or similar!</p> <ul style="list-style-type: none"> ▷ Keep a safety distance of at least 0.3 m.

1157.841/06-EN

	<p style="background-color: #e67e22; color: white; padding: 5px;">⚠ DANGER</p> <p>Pump acting as a generator when running in reverse Danger to life from hazardous induction voltage at the motor terminals!</p> <ul style="list-style-type: none"> ▷ Prevent the fluid from flowing back by closing the shut-off elements.
	<p style="background-color: #e67e22; color: white; padding: 5px;">⚠ WARNING</p> <p>Strong magnetic field Danger of crushing injuries when pulling out the rotor! Strong magnetic field can suddenly pull the rotor back into its original position! Danger of magnetic parts near the rotor being attracted!</p> <ul style="list-style-type: none"> ▷ The rotor must only be removed from the motor housing by authorised specialist personnel. ▷ Remove any magnetic parts from the vicinity of the rotor. ▷ Keep the assembly area clean. ▷ Keep a safety distance of at least 0.3 m from electronic components.
	<p style="background-color: #e67e22; color: white; padding: 5px;">⚠ WARNING</p> <p>Hot surface Risk of injury!</p> <ul style="list-style-type: none"> ▷ Allow the pump set to cool down to ambient temperature.

- ✓ The pump set has been de-energised and secured against unintentional start-up.
- ✓ The pump has cooled down to ambient temperature.
- ✓ A container for collecting the fluid has been positioned underneath the pump set.
 1. Close the shut-off elements.
 2. Disconnect the discharge nozzle and suction nozzle from the piping.
 3. Depending on the pump size / motor size, remove the supports from the pump set.
 4. Remove the complete pump set from the piping.

9 Trouble-shooting

	 WARNING
	<p>Improper work to remedy faults</p> <p>Risk of injury!</p> <p>▷ For any work performed to remedy faults, observe the relevant information given in this operating manual and/or in the product literature provided by the accessories manufacturer.</p>

If problems occur that are not described in the following table, consultation with the customer service is required.

- A** Pump is running, but does not deliver
- B** Pump starts up but stops again immediately
- C** Noises during pump operation

E01 to E17 Error code on the display

I10, I14 Error code on the display

Table 38: Trouble-shooting

Error value	Possible cause	Remedy ⁷⁾
A	<ul style="list-style-type: none"> ▪ Master switch switched off ▪ Defective fuse ▪ Electrical connection incorrect or not connected (alarm displayed) 	<ul style="list-style-type: none"> ▪ Check master switch. ▪ Check fuse. ▪ Check electrical connection of the pump.
B	<ul style="list-style-type: none"> ▪ Remote ON/OFF contact has been removed. ▪ Overcurrent at the motor (alarm displayed) 	<ul style="list-style-type: none"> ▪ Fit connecting bridge for remote ON/OFF function.
C	<ul style="list-style-type: none"> ▪ Air in the system ▪ Shut-off elements closed 	<ul style="list-style-type: none"> ▪ Vent the system and the pump. (⇒ Section 6.1.2, Page 33) ▪ Open the shut-off elements.
E01	<ul style="list-style-type: none"> ▪ Excessive temperature 	<ul style="list-style-type: none"> ▪ Let the pump cool down for some minutes. Manually interrupt power supply for a short period. Check that the pump starts up again. ▪ Verify that the fluid temperature and ambient temperature are within the permissible temperature ranges.
E02	<ul style="list-style-type: none"> ▪ Overcurrent ▪ In the case of externally forced flow, alarm E17 is active in addition. 	<ul style="list-style-type: none"> ▪ De-energise the pump for 1 minute; then re-energise it.
E03	<ul style="list-style-type: none"> ▪ Internal fault 	<ul style="list-style-type: none"> ▪ De-energise the pump for 1 minute; then re-energise it. ▪ Carry out a firmware update.
E04	<ul style="list-style-type: none"> ▪ Pump rotor blocked 	<ul style="list-style-type: none"> ▪ De-energise the pump for 1 minute; then re-energise it. ▪ If the pump is still blocked, properly dismantle and deblock it.
E05	<ul style="list-style-type: none"> ▪ Temperature limit reached 	<ul style="list-style-type: none"> ▪ To prevent a temperature increase inside the pump the speed has been reduced. ▪ Once the pump has cooled down, it will revert to its normal operating data. If the temperature continues to rise, E01 will be indicated on the display. ▪ Verify that the fluid temperature and ambient temperature are within the permissible temperature ranges.

7) Release pump set pressure before attempting to remedy faults on parts which are subjected to pressure.

Error value	Possible cause	Remedy ⁷⁾
E06	<ul style="list-style-type: none"> ▪ Voltage error 	<ul style="list-style-type: none"> ▪ Verify that the supply voltage matches the data on the name plate. ▪ Measure the mains voltage.
E08	<ul style="list-style-type: none"> ▪ Motor fault ▪ Incorrect rotor angle caused by blocked rotor, for example. ▪ Incorrect rotor angle caused by externally forced flow. Alarm E17 is active. 	<ul style="list-style-type: none"> ▪ De-energise the pump for 1 minute; then re-energise it. ▪ If the faults/alarms have not been cleared, have the motor checked by KSB Service.
E11	<ul style="list-style-type: none"> ▪ Broken wire of temperature sensor (NTC thermistor) in the motor 	<ul style="list-style-type: none"> ▪ Have it checked by KSB Service.
E12	<ul style="list-style-type: none"> ▪ Firmware not compatible 	<ul style="list-style-type: none"> ▪ Carry out a firmware update.
E13	<ul style="list-style-type: none"> ▪ No pump model stored. Pump stops. 	<ul style="list-style-type: none"> ▪ Carry out a firmware update. ▪ Enter pump size as indicated on the name plate.
E17	<ul style="list-style-type: none"> ▪ Externally forced flow 	<ul style="list-style-type: none"> ▪ Prevent or reduce externally forced flow.
I10	<ul style="list-style-type: none"> ▪ Broken wire of 0 - 10 V control signal (Pump is not stopped. Can be set via KSB ServiceTool) 	<ul style="list-style-type: none"> ▪ Check the analog 0 - 10 V control signal.
I14	<ul style="list-style-type: none"> ▪ For dual pumps both pumps are programmed as "left pump". Pumps keep running. 	<ul style="list-style-type: none"> ▪ Carry out firmware update for "right pump".

10 Related Documents

10.1 Exploded view with list of components

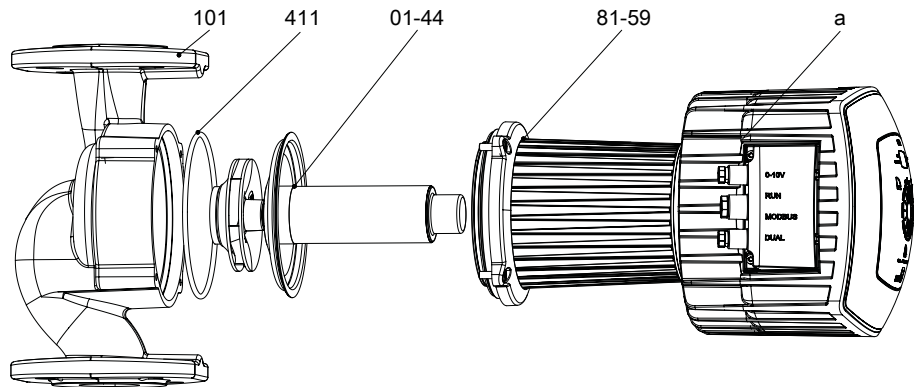

Fig. 29: Exploded view

Table 39: List of components

Part No.	Description	Part No.	Description
01-44	Rotor	101	Pump casing
81-59	Stator	411	Joint ring
a	Heat sink including frequency inverter		

10.2 Wiring diagram

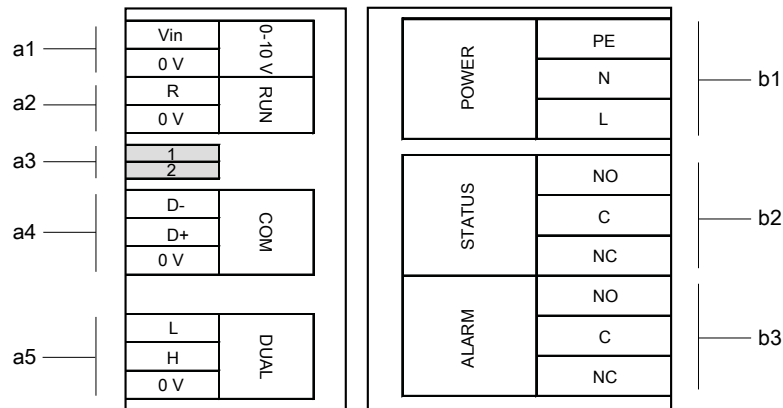

Fig. 30: Wiring diagram

Connections for control cables	
a1	External 0 - 10 V
a2	Remote ON/OFF
a3	Terminating resistor for Modbus cable (DIP switches)
a4	Modbus
a5	Dual-pump configuration
Connections for power supply and general fault message	
b1	Power supply 1~ 230 V AC +/- 10 %, 50 Hz
b2	"In operation" message
b3	General fault message

11 EU Declaration of Conformity

Manufacturer: **KSB SE & Co. KGaA**
Johann-Klein-Straße 9
67227 Frankenthal (Germany)

This EU Declaration of Conformity is issued under the sole responsibility of the manufacturer.

The manufacturer herewith declares that **the product:**

Calio Z

From serial number: xxxxxxxx-A201920-00001

- is in conformity with the provisions of the following directives / regulations as amended from time to time:
 - Pump (set): 2006/42/EC Machinery Directive
 - 2009/125/EC: Creation of a framework for the stipulation of requirements for the environmentally compatible design of energy-related products (Ecodesign Directive), Regulation No. 641/2009 and/or 622/2012
 - Electrical components⁸⁾: 2011/65/EU Restriction of the use of certain hazardous substances in electrical and electronic equipment (RoHS)
 - 2014/30/EU: Electromagnetic Compatibility (EMC)
 - 2014/35/EU: Electrical Equipment Designed for Use within Specific Voltage Limits (Low Voltage)

The manufacturer also declares that

- the following harmonised international standards have been applied:
 - EN 809
 - EN 60335-1, EN 60335-2-51
 - EN 61000-6-1, EN 61000-6-3
 - EN 16297-1, EN 16297-2

Person authorised to compile the technical file:

Jennifer Watson
Project Coordination Pump Systems and Drives
KSB SE & Co. KGaA
Johann-Klein-Straße 9
67227 Frankenthal (Germany)

The EU Declaration of Conformity was issued in/on:

Frankenthal, 1 January 2020

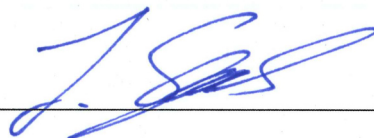

Jochen Schaab
Head of Product Development Pump Systems and Drives
KSB SE & Co. KGaA
Johann-Klein-Straße 9
67227 Frankenthal

8) Where applicable

Index

A

Applications 8
Automatic functions 16

B

Bearings 15

C

Commissioning 33
Connections 15

D

Design 15
Designation 14
Disposal 13
Drive 15

E

Event of damage 6

F

Faults
 Causes and remedies 66
Fluid handled
 Density 36

I

Installation at site 19
Intended use 8

K

Key to safety symbols/markings 7

M

Manual functions 16

N

Name plate 15

O

Operating limits 35
Operating modes 16
Other applicable documents 6

P

Piping 22
Preservation 12, 37
Product description 14

R

Return to supplier 13
Returning to service 37

S

Safety 8
Safety awareness 9
Scope of supply 18
Shutdown 37
Signalling and display functions 16
Start-up 34
Storage 12, 37

T

Transport 11

W

Warnings 7
Warranty claims 6



KSB SE & Co. KGaA

Johann-Klein-Straße 9 • 67227 Frankenthal (Germany)

Tel. +49 6233 86-0

www.ksb.com